

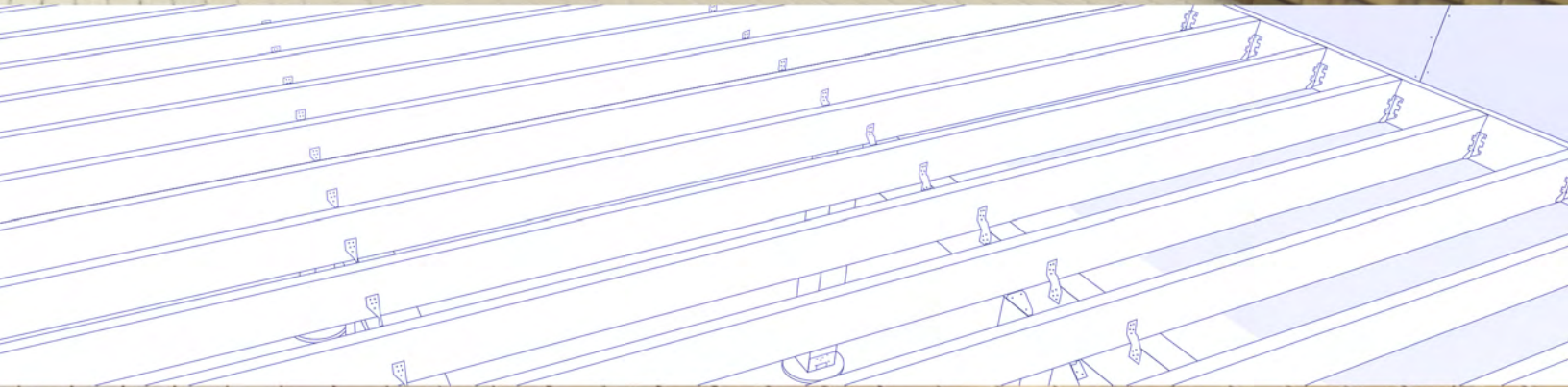

## Deck Connection and Fastening Guide



RECOMMENDATIONS FOR THE CONSTRUCTION OF BUILDING CODE-COMPLIANT DECKS

# Continuous Load Path

## Continuous Load Path

As with your home, your deck should be built using a “continuous load path.” The continuous load path is an engineering concept that, when constructed, assures loads are completely transferred from point of application to the foundation via the structural components and connections. Continuous load paths are typically constructed to resist the forces from gravity (vertical), lateral (horizontal) and uplift loads. For example, the vertical load path would effectively transfer the weight (load) of the deck and everything on it through its frame, to the foundation or the adjacent support structure (typically your home), and finally to the ground. If your deck is built with a continuous load path, it will be better equipped to resist forces, such as occupancy, wind, snow and earthquakes. Visit [strongtie.com/deckcenter](http://strongtie.com/deckcenter) to learn more about achieving a continuous load path in the construction of your deck.

**A safe deck is built with fasteners and connectors that create a continuous load path.**

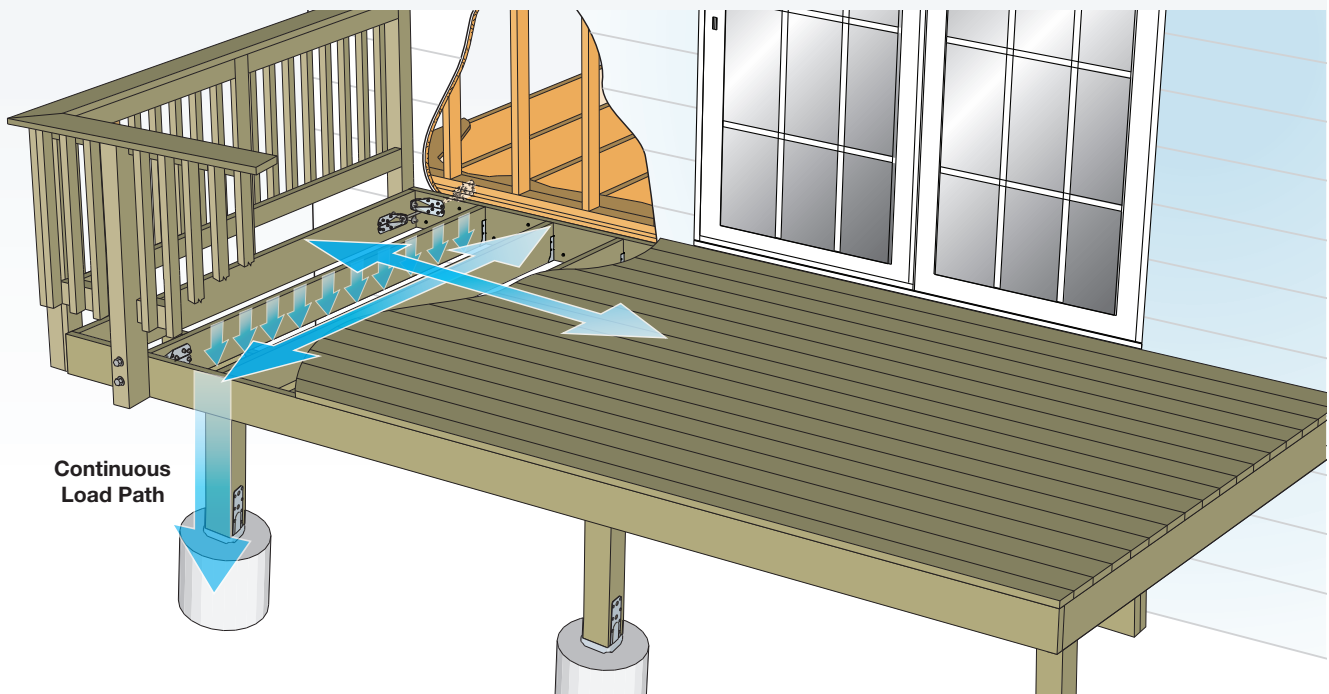
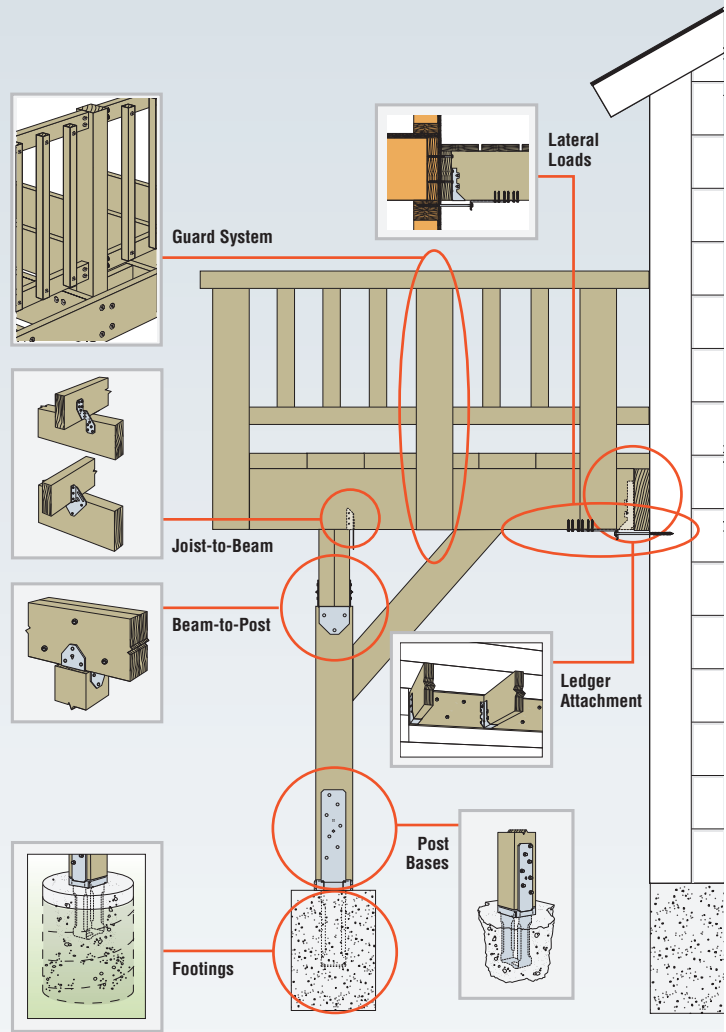

# Contents

Continuous Load Path . . . . .	2	Guard Post to Deck Framing. . . . .	30–33
<b>Build a Safe, Strong Deck.</b> . . . .	<b>4</b>	Guardrail Infill Component Connections . . . . .	34–35
Introduction . . . . .	5	Stair Stringers and Treads . . . . .	36
Code Concerns. . . . .	6–7	<b>Performance Fasteners for Decks.</b> . . . .	<b>37</b>
Critical Deck Connections Checklist . . . . .	8–9	Structural Wood Fastening . . . . .	38
Existing Decks: Retrofit or Replace? . . . . .	10–11	Screws for Decking . . . . .	39
<b>Help for Your Deck Planning</b> . . . . .	<b>12</b>	Color-Match Fasteners for Composite and PVC Decking . . . . .	40
Deck Planner Software™ . . . . .	13	Hidden Deck Fastening. . . . .	41
Fastener Software. . . . .	14	Nails for Decking . . . . .	42
DCA6 . . . . .	15	Quik Drive® Auto-Feed Screw Driving Systems for Decking . . . . .	43
<b>Deck Solutions for a Safe, Code-Compliant Deck . .</b>	<b>16</b>	<b>Fastener Selection Guidance.</b> . . . .	<b>44</b>
Footings . . . . .	17	Connector Fastener Types . . . . .	45
Post Bases Installed . . . . .	18–20	Fastener Information . . . . .	46
Beam Assemblies and Beam-to-Post Connections . . .	21	<b>Mitigating Corrosion Risk.</b> . . . .	<b>47</b>
Beam-to-Post Connections . . . . .	22	Selecting Connector and Fastener Coatings. . . . .	48
Ledger Connections . . . . .	23–25	Corrosion Information . . . . .	49–50
Lateral Connection to Primary Structure . . . . .	26		
Joists Terminating into Beam/Ledger . . . . .	27–28		
Joists Bearing on a Beam . . . . .	29		

## Visit the Deck Center at [strongtie.com/deckcenter](https://strongtie.com/deckcenter)

### Everything You Need in One Place

We have brought all of our information and training on building stronger, safer decks together in one location to make learning easier than ever.

### A Word About Building Codes

This guide recommends connectors and fasteners for deck construction that help the deck builder meet the requirements of the 2018/2021 International Building Code® and the 2018/2021 International Residential Code®. The information contained here is a summary of the requirements of these codes as they pertain to the connections highlighted in this guide. The building codes contain other requirements regarding aspects of deck construction that are not addressed here; check the codes for details. Check with your local building department to verify what building codes have been adopted in your area.

### Product Approvals

**Selection of products based upon performance and/or suitability for a specific application should be made by a qualified professional.** Simpson Strong-Tie recommends that deck designs be approved by the local building department before construction begins.

*International Building Code and International Residential Code are registered trademarks of their respective organizations.*

### Limited Warranty

For information regarding the Simpson Strong-Tie Limited Warranty, see [strongtie.com/limited-warranties](https://strongtie.com/limited-warranties) or call (800) 999-5099.

### Resources to Make Building Easier

- Deck Planner Application, [strongtie.com/deckplanner](https://strongtie.com/deckplanner) — deck design software
- Fastener Finder Application, [strongtie.com/ff](https://strongtie.com/ff) — fastener identification software
- Fastener Designer Application, [strongtie.com/fastenerdesigner](https://strongtie.com/fastenerdesigner) — fastener load and application mapping software
- “Deck Inspection for New and Existing Construction,” [strongtie.com/training](https://strongtie.com/training) — Simpson Strong-Tie deck training course
- “DCA 6 Residential Wood Deck Construction Guide,” [awc.org](https://awc.org) — prescriptive guide for residential decks
- NADRA Deck Evaluation Checklist, [nadra.org/deck-safety](https://nadra.org/deck-safety)



**Build  
a Safe,  
Strong  
Deck**



# Introduction

## Build a Safe, Strong Deck

A beautiful deck is about more than the framing and connections. It's about the experiences and connections that happen between people while they are enjoying their time outside. Outdoor living can enhance our enjoyment of life immeasurably, and a well-built deck can make an important contribution to that aspect of our lifestyle. Simpson Strong-Tie believes that a beautiful deck must also be safe and strong.



## Deck Construction and Fastening Tips

- Before beginning construction, allow your decking materials to acclimate to the jobsite conditions. A freshly pressure treated deck board can contain over a gallon of liquid.
- Select the proper fastener based on the importance of the connection, exposure, and the materials that are being fastened. Consult pp. 45–46 and pp. 48–50 of this guide or [strongtie.com](http://strongtie.com) for guidelines on choosing the correct fastener.
- Consider using 300 Series stainless-steel fasteners when elevated corrosion conditions may exist, such as presence of de-icing salts or close proximity to swimming pools, hot tubs, sprinklers, ponds, foliage and other moisture sources.
- Inadequate gap spacing between boards can put additional load on the fasteners and lead to broken screws or nail pops. Spacing for wood decks depends on wood species and moisture content.
- For composite decking, consult manufacturer fastening requirements and installation instructions related to spacing.
- If the deck is attached to a wall or floor assembly of wood-frame construction, approved corrosion-resistant flashing should be applied to prevent water entry or penetration into the building.
- Use caution to avoid overdriving fasteners during installation. Overdriving can cause fastener breakage and create a counterbore where water can pool, facilitating corrosion and decay.
- Allow for proper water drainage. A deck should slope away from the structure a minimum of 1/8" to 1/4" per every 12" to reduce the possibility of standing water.
- For composite decking to be installed diagonally, reduce the on-center joist spacing following recommendations of the deck board manufacturer. For 5/4 wood decking to be installed diagonally, the spacing for supporting framing should not exceed 16" on-center.
- Adequate ventilation is necessary to minimize cupping, warping and other weathering related defects. Construct the deck a minimum of 18" off the ground to allow proper air circulation. If this is not possible, install a plastic film moisture barrier under the deck.
- Proper maintenance is essential. Staining and sealing, along with periodic inspection of fasteners and hardware, will potentially add years to the life of the deck.

## Code Concerns

### Do Decks Really Need to Meet Building Code Requirements?

Because decks may look relatively simple to build, many people do not realize that they are structures that need to be constructed to meet minimum standards and resist certain loads. Like a house, or any other building, a deck must support the weight of people and objects placed on it, as well as lateral and uplift loads that can act on the deck as a result of occupant movement, wind or seismic activity. The 2018/2021 versions of both the IBC and IRC contain language outlining the general design requirements of structures. This excerpt from the 2018/2021 IRC (Section R301.1) represents a summary of the intent of both codes: “The construction of buildings and structures in accordance with the provisions of this code shall result in a system that provides a complete load path that meets the requirements for the transfer of loads from their point of origin through the load-resisting elements to the foundation.”

The concept of the continuous load path is described on p. 2.

Starting with the 2015 edition, the IRC has contained an entire section describing specific requirements for safe deck construction. These have been refined and increased in every edition since then. These requirements are a start for safe construction of every deck. Some smaller decks that are low to the ground are allowed by the IRC to be exempted from building permit requirements. However, that does not mean that they are exempt from having to meet the minimum basic code requirements.





# Code Concerns

## Common Building Code Violations

The following code requirements can be easily overlooked in deck construction:

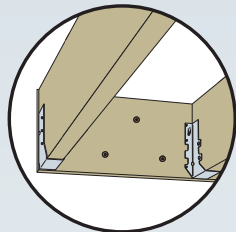

### 1. Proper fastening of the ledger to the house

IRC and IBC codes prohibit the “use of toenails or nails subject to withdrawal” when making ledger connections, yet a number of deck failures each year result due to using these or other types of improper fasteners. For more information, see p. 23.

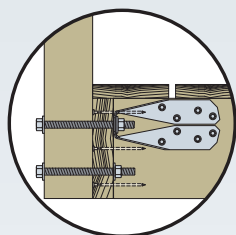

### 2. Proper fastening of guard posts to the deck

IRC and IBC codes require the guard post to resist a 200-pound design load. This load, applied horizontally at the top of the guard post, creates a large leverage force where the guard post attaches to the deck framing. For more information, see p. 31.

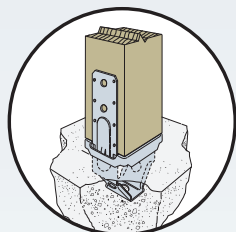

### 3. Post-base connections

IRC and IBC codes require posts “be restrained to prevent lateral displacement at the bottom end.” This requirement is important because most decks cannot safely support part or all of their load if a post base can move. For more information, see pp. 18-20.

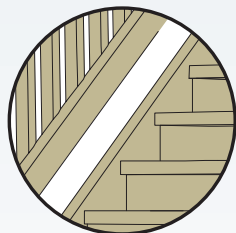

### 4. Openings in guards and stair railings

IRC and IBC codes place a limit on the size of openings, for the occupants’ safety in case of tripping or falling, and for the safety of small children. For more information, see p. 36.

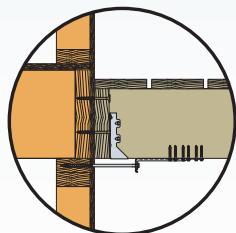

### 5. Lateral-load solutions

IRC and IBC codes require that a deck be designed for both the vertical and lateral loads. Deck failures with injuries occur when people move around on a deck and create that lateral movement, causing the deck to pull away from the primary structure before collapsing. For more information, see p. 26.

# Critical Deck Connections Checklist

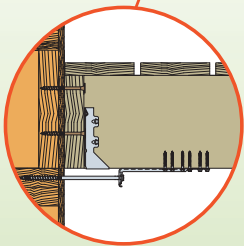
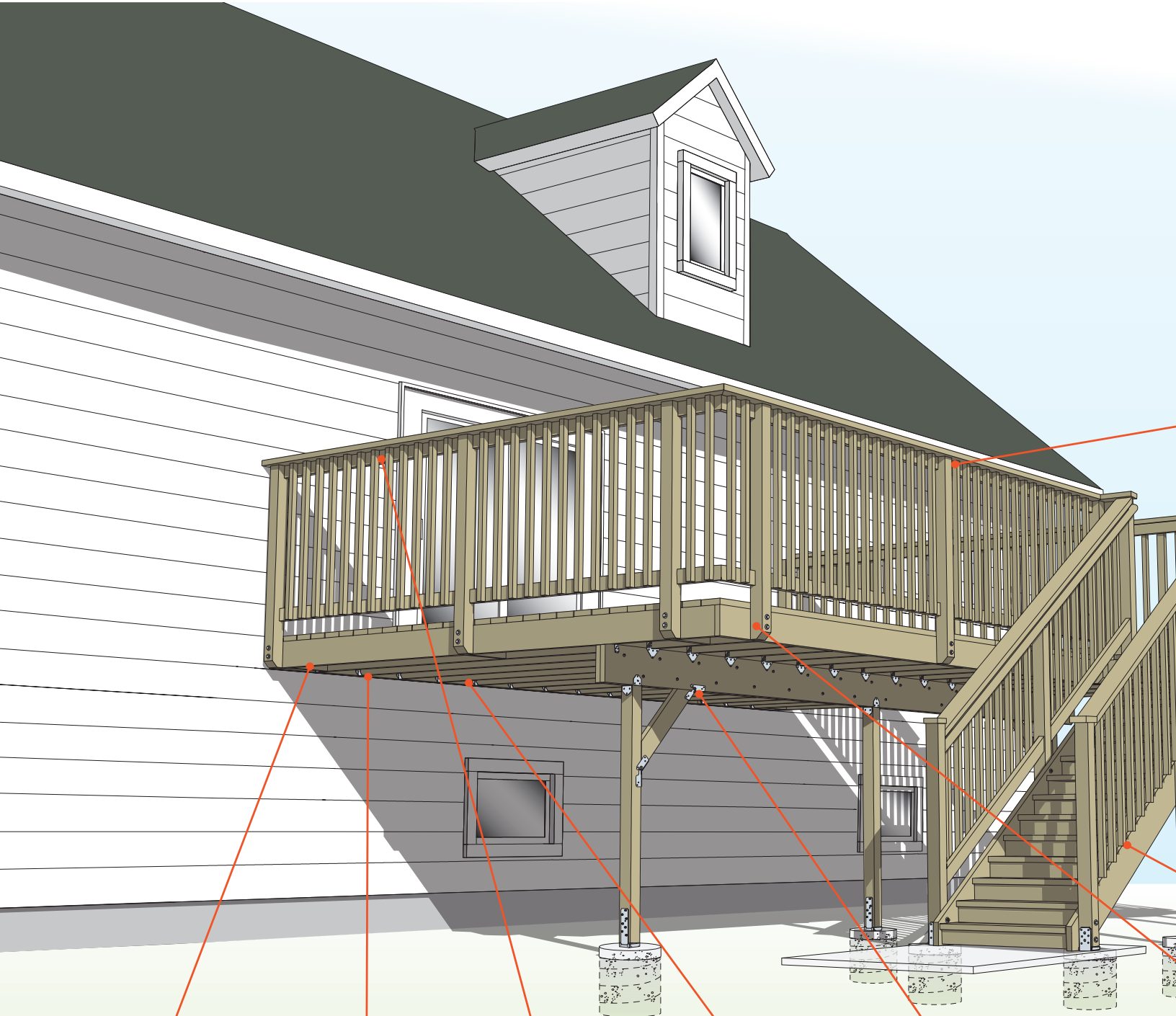

**Lateral-Load Connection**  
(p. 26)

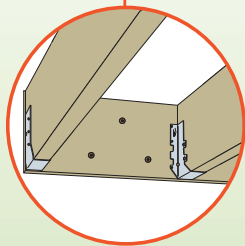

**Joist to Ledger**  
(p. 27)

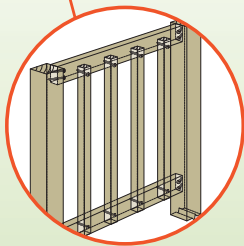

**Guardrail Infill Component Connections**  
(p. 35)

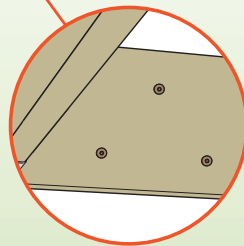

**Ledger Attachment**  
(p. 23)

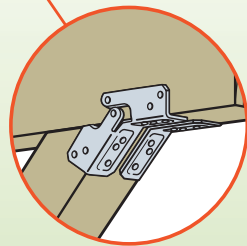

**Knee Brace**  
(p. 22)



# Critical Deck Connections Checklist

To build a safe, building-code-compliant deck, it's essential that the deck construction establish a continuous load path using a system of key connections throughout the deck framing. When this system of connections is made properly, loads are transferred through the deck frame and into the ground and/or the adjacent structure to which the deck is connected.

The connections shown below are necessary in order to create an effective continuous load path.

For information on the inspection of existing decks, see p. 10, and for resources, see p. 3.

Use the diagram below to determine which deck connections are needed for new construction or which may need to be retrofitted for existing construction. For ledger connections to concrete and/or brick, see pp. 24–25.

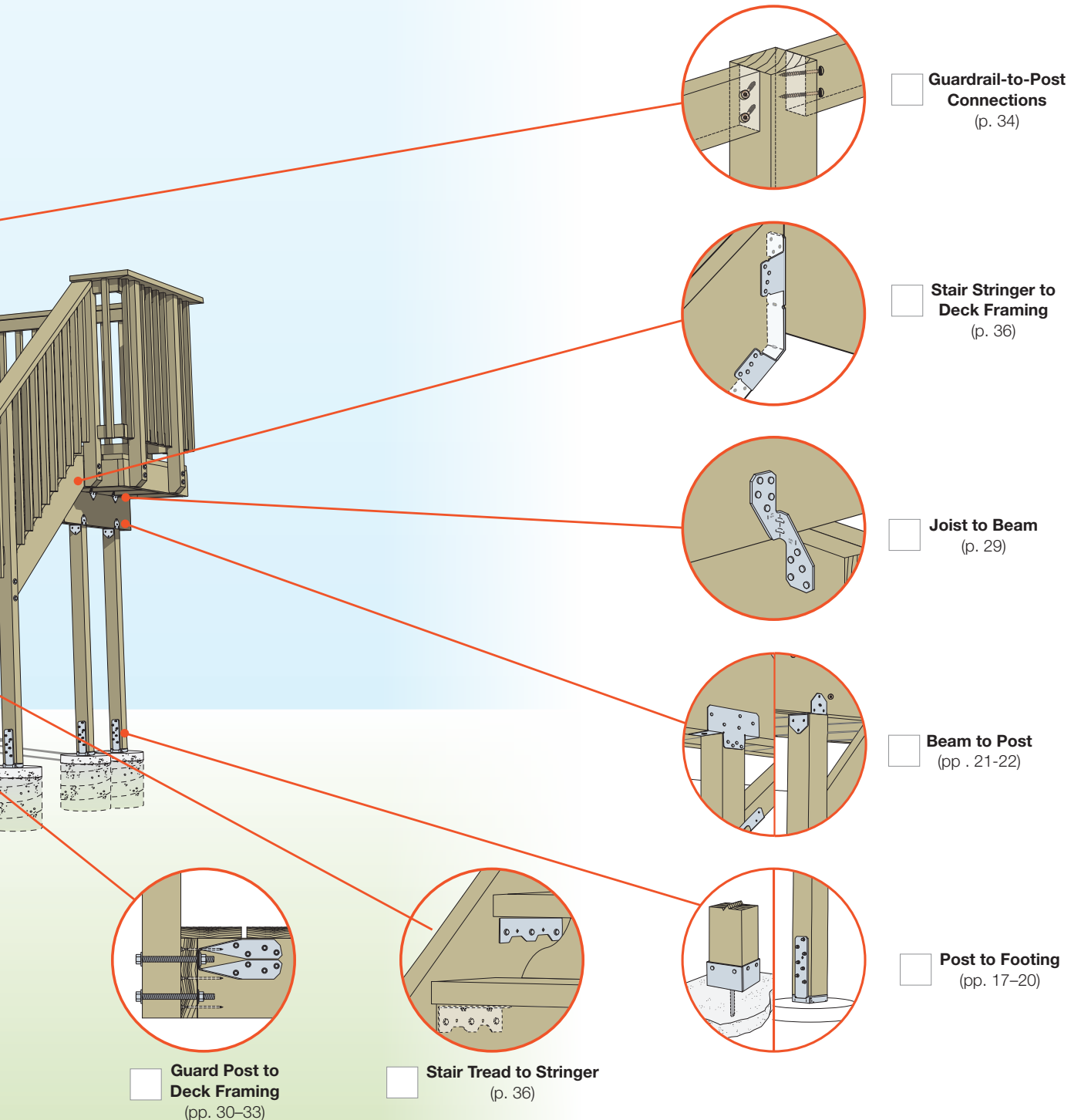

# Existing Decks: Retrofit or Replace?

## Do I Need to Retrofit?

### Retrofitting an Existing Deck

It's estimated that of the approximately 60 million existing decks, half are past their useful life and need to be replaced. Experts believe that many of these decks are potentially unsafe. In situations where it's not feasible to rebuild an existing deck, it may be preferable to retrofit it by applying hardware to existing framing members. Many of the products shown in this guide may be installed after deck framing is in place and can improve the safety of the structure and help bring it within the requirements of the code.

### Life Expectancy of Decks

Most experts agree that the average life expectancy of a deck is 10 to 20 years. Decks are exposed to the elements, which can cause deterioration. It's important that decks are properly inspected and maintained on a routine basis. If you are unsure what to inspect for or how often, it's best to consult with a qualified professional, such as a structural engineer, architect, home inspector or contractor, in order to make sure the deck is safe.

## Five Things to Look for on an Existing Deck

It is recommended that you inspect your deck annually for issues that need to be addressed. It's best to do this prior to seasons when you use your deck most. When inspecting a deck to determine overall safety and compliance with building codes, look at the five areas below. Use this checklist to help ensure a thorough evaluation.



### 1. Improper Connections

Any connections that do not meet the requirements discussed in this guide can compromise the safety of the deck. In many cases, toenailing (i.e., joining two wood members with angled nailing) does not constitute a proper connection. Connectors must be installed with the correct fastener.

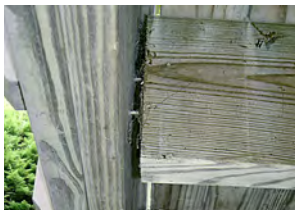

### 2. Loose Connections

Vital connections may have degraded. Wobbly railings, loose stairs and ledgers that appear to be pulling away from the adjacent structure are all causes for concern.



### 3. Corrosion

Metal connectors and fasteners can corrode, especially if a product with insufficient corrosion resistance was originally installed. See pp. 49–50 for more information on corrosion.



### 4. Decay

Wood can decay with exposure to the elements. Deck framing members that have decayed may no longer be able to perform the function for which they were intended.



### 5. Splitting

As wood ages, it is common for splitting to develop. Large cracks or excessive splitting can weaken deck framing members.

# Existing Decks: Retrofit or Replace?

## Connector Solutions for Retrofitting

The following connectors are some of the products that may be suitable for deck retrofit. Selection of products based upon performance and/or suitability for a specific application should be made by a qualified professional. Simpson Strong-Tie recommends that deck designs be approved by the local building department before work begins.

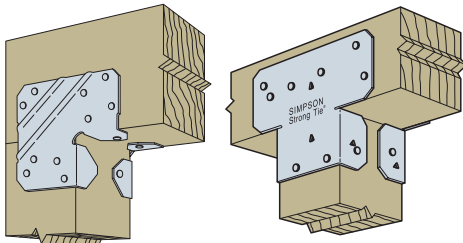

### LCE/AC Post Caps

Two-piece cap may be installed before or after lumber is in place.

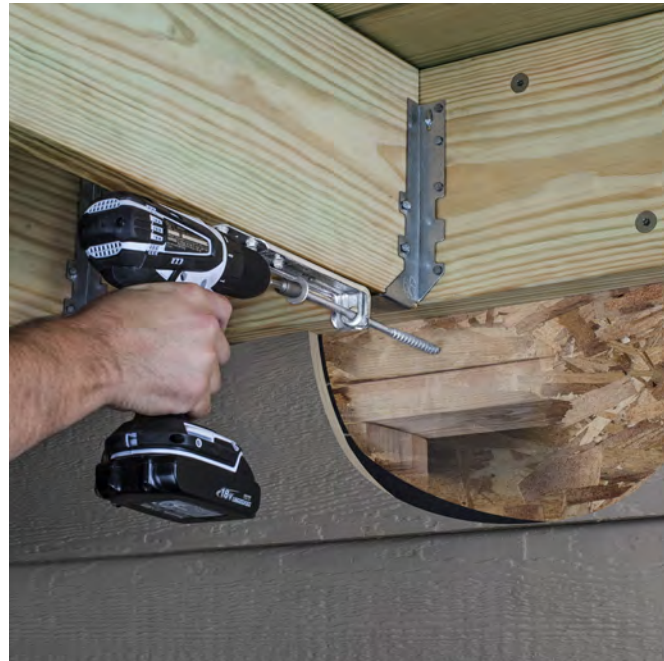

Siding not shown for clarity

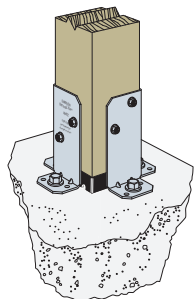

### RPBZ Retrofit Post Base

Reinforcement for post applications.

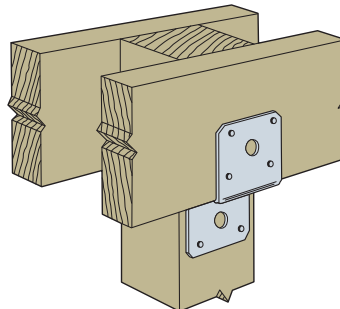

### DJTZ

Connects beams at the side of the post.  
*(available in ZMAX® coating or in stainless steel)*

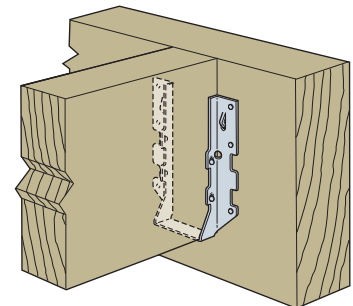

### LUS Joist Hanger

Provides bearing and uplift resistance, features double-shear nailing for added strength.

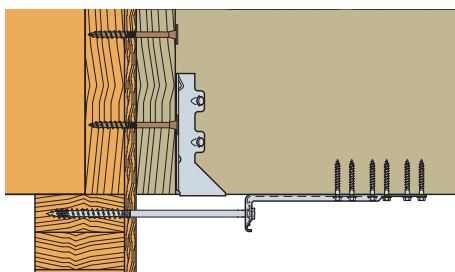

### DTT1Z Deck Tension Tie

Lateral connections into wall plates, header or studs.  
*(siding not shown for clarity)*

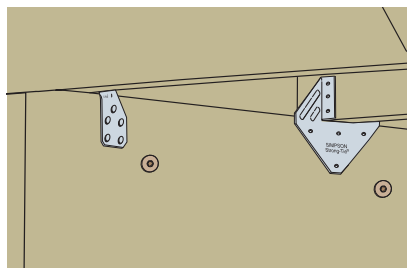

### H1 Hurricane Tie

Attaches to both sides of the joist.

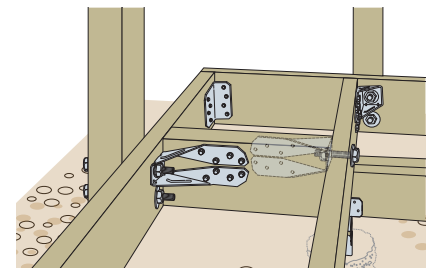

### DTT2 Deck Tension Tie

Horizontal application fastening guard post to deck framing.  
*(available in ZMAX coating or in stainless steel)*

# Help for Your Deck Planning



Deck-design software provides a user-friendly means of planning, designing and visualizing new deck construction, as well as deck-remodel projects.

Simpson Strong-Tie® Deck Planner Software helps you quickly design a custom deck, whether for retrofits or a new build. Once the design is completed, the tool dynamically generates building permit submittal pages and a project materials list.

Deck Planner Software allows for the design of decks with fast and powerful editing tools:

- Design in 2D or 3D environments
- Use the deck-shaping tools to insert specific deck dimensions
- Select from different wood species for your framing lumber
- Easy-to-use deck drawing tool allows user to draw the outline of their deck before designing
- Deck Planner Software is available for PC and iOS devices.

The software can also generate full deck plans, specifications and a bill of materials.

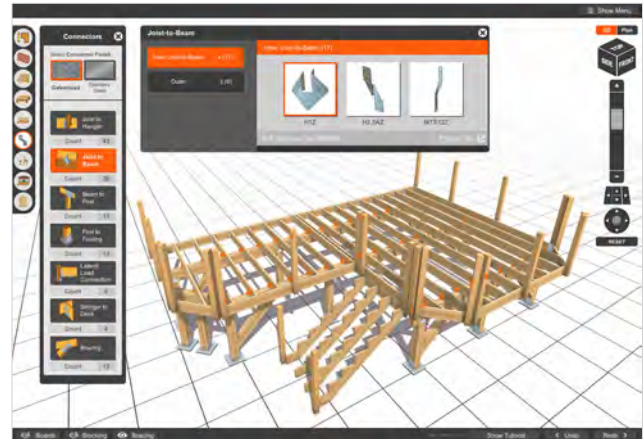
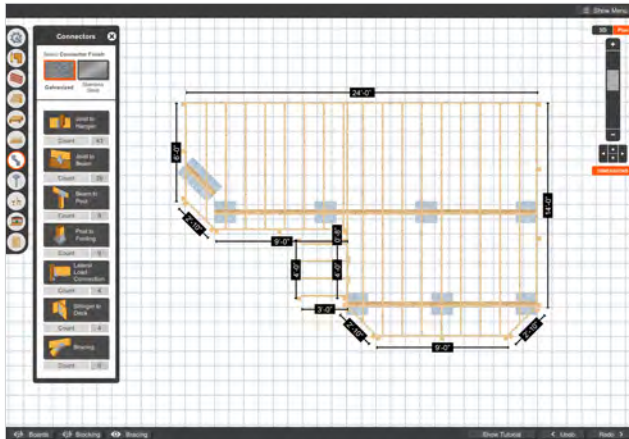

# Fastener Software

## Select with Fastener Designer

Fastener Designer is a web-based application that helps you find alternatives to the specified fasteners in your plans, giving you more design flexibility. This application quickly finds alternatives to standard NDS fasteners for six common applications:

- Withdrawal loading
- Lateral load parallel to grain
- Lateral load perpendicular to grain
- Multi-ply connections
- Ledger connections
- Sole-plate-to-rim board

Results come with detailed load calculations for both the NDS fastener and the recommended Simpson Strong-Tie structural screw. See [strongtie.com/fastenerdesigner](http://strongtie.com/fastenerdesigner) for more information.

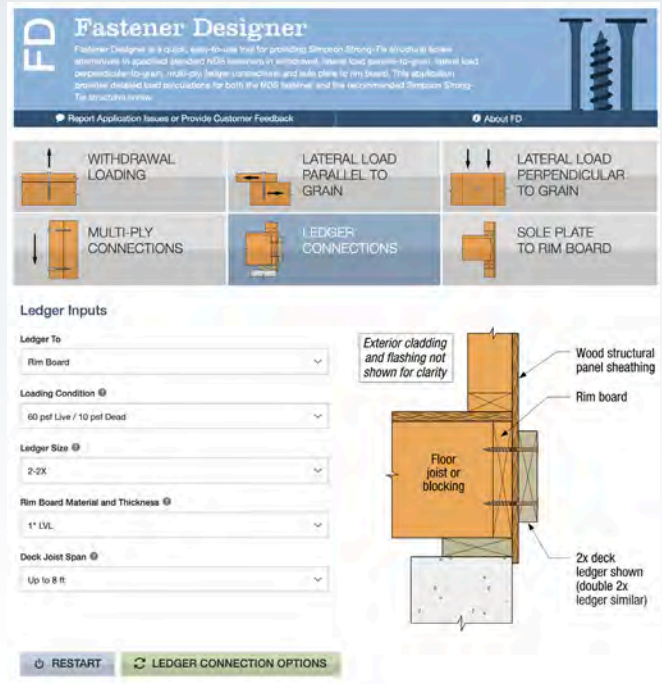

## Search with Fastener Finder

Quickly search our wide array of fasteners to find exactly what you need. Search by multiple criteria, such as application, fastener type, finish/material and model number. Explore our extensive product line in seconds in order to compare, specify or buy. Find the right fastener now by accessing our online Fastener Finder. Visit our website at [strongtie.com/ff](http://strongtie.com/ff).

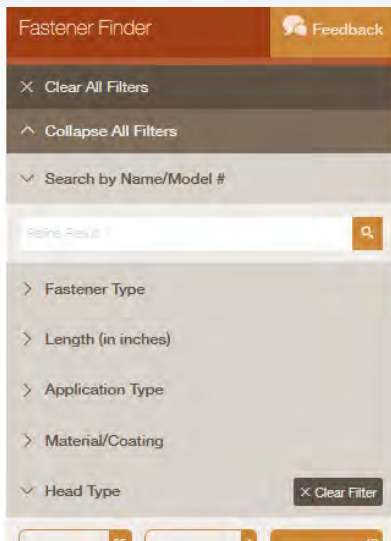

Your Selections: Point Type : Multiple Values Drive Type : Multiple Values Head Type : Multiple Values

Sort by Name (Z to A) 60 Refined Results Displayed Below

### Strong-Drive® SDWS FRAMING Screw



The Strong-Drive SDWS Framing screw is a code-listed, multi-purpose structural fastener that can be used in framing applications, remodeling and interior or exterior DIY projects.

Fastener Type: Hand-Drive Screw

Applications:

- Multipurpose wood-to-wood and engineered-wood applications, including framing, indoor/outdoor projects

Model No.	Coating/Material	Length (in.)	Head Diameter (in.)	Shank Diameter (in.)	Drive Type	Head Type	Thread Type	Thread Length	Point Type	Packaging Qty.
SDWS16212Q	Quik Guard® Coating	2 1/2	0.440	0.160	T25 6-Lobe	Low Profile Head	Serrated Threads	1.125	SawTooth™ Type-17 Point	1000

# DCA6 — A Prescriptive Guide for Residential Wood Decks

## What Is the DCA6?

The *Design for Code Acceptance DCA6 Prescriptive Residential Wood Deck Construction Guide* — 2015 IRC version publication by American Wood Council, provides prescriptive methods for the construction of single-level decks to meet the provisions of the 2015 International Residential Code (IRC). Information is included where the IRC has yet to develop provisions. The prescriptive methods shown are not meant to limit the use of alternate means and methods that are not shown. If there are any conflicts between the DCA6 and IRC, the IRC provisions govern. The guide is available for download at [awc.org](http://awc.org).

### What is the scope of DCA6?

- The guide applies to single-level residential wood decks.
- Maximum live or snow loads are 40 psf. Large concentrated loads, such as hot tubs, are outside the scope.
- Lateral loads are addressed to the extent of the IRC provisions.

### Can the current DCA6-2015 IRC edition be used with 2018 or 2021 IRC editions?

- The guide is in the process of being updated to the new IRC editions. The current DCA6-2015 IRC edition could be used for 2018 or 2021 IRC designs that have the same scope.

TECHNICAL BULLETIN



**Connection Solutions to Meet the DCA6 Prescriptive Residential Wood Deck Construction Guide**  
(Based on the 2015 International Residential Code)

The Design for Code Acceptance DCA6 Prescriptive Residential Wood Deck Construction Guide — 2015 IRC version publication by American Wood Council, provides prescriptive methods for the construction of single-level decks to meet the provisions of the 2015 International Residential Code (IRC). Information is included where the IRC has yet to develop provisions. The prescriptive methods shown are not meant to limit the use of alternate means and methods that are not shown. If there are any conflicts between the DCA6 and IRC, the IRC provisions govern.

This technical bulletin provides Simpson Strong-Tie® connector, fastener, and anchor solutions to meet the DCA6 provisions. Additional alternate methods are included. Reference to other Simpson Strong-Tie documentation is made for full installation information and additional technical detail.

Simpson Strong-Tie recommends that deck designs be approved by the local building department before construction begins.



Courtesy, American Wood Council, Leesburg, VA

**General notes for the use of this document:**

- The DCA6 scope applies to single-level residential wood decks. Maximum live or snow loads are 40 psf. Large point loads, such as hot tubs, are outside the scope. Lateral loads are addressed to the extent of the IRC provisions.
- Connector, fastener and anchor solutions contained in this document are equivalent to DCA6 provisions, unless noted otherwise. Additional options may be available on [strongtie.com](http://strongtie.com).
- Framing lumber wood species: SPF, HF, DF and SP lumber.
- Solutions include wet service adjustment.
- Nails for nailed stainless steel connectors must be Strong-Drive® SCNR Ring-Shank Connector Nails. Refer to p. 11 for further information.
- Nailed connectors may be installed alternately with Strong-Drive SD Connector screws, unless noted otherwise. Refer to p. 11 for substitution information.
- A worksheet is included to assist in the count of connectors, fasteners and anchors for a project.

Table of Contents

Decking; Beam Assembly; Joist-to-Beam..... 2	Guard Post Attachment; Guard Infill..... 8
Joist Hangers; Post-to-Beam ..... 3	Stair Connections ..... 9
Post-to-Beam; Diagonal Bracing ..... 4	Trimmer Joist Hangers..... 9
Rim Joist Connection Details; Post-to-Footing..... 5	Corrosion Information ..... 10
Ledger Board Attachments..... 6	Simpson Strong-Tie Fasteners ..... 11
Deck Lateral Loads..... 7	Worksheet ..... 12

1

Technical bulletin T-C-DCA6DECK provides connector, fastener and anchor solutions to meet the DCA6 provisions. Additional alternate methods are included.

F-DECKCODE22 © 2022 Simpson Strong-Tie Company Inc.

(800) 999-5099 | [strongtie.com](http://strongtie.com)

Deck Connection and Fastening Guide | 15

# Deck Solutions for a Safe, Code- Compliant Deck



# Footings

In order for posts to properly resist various types of loads, they must be supported by, and anchored to, concrete footings. Thin concrete slabs and precast concrete piers do not qualify as proper footings for decks attached to the structure.

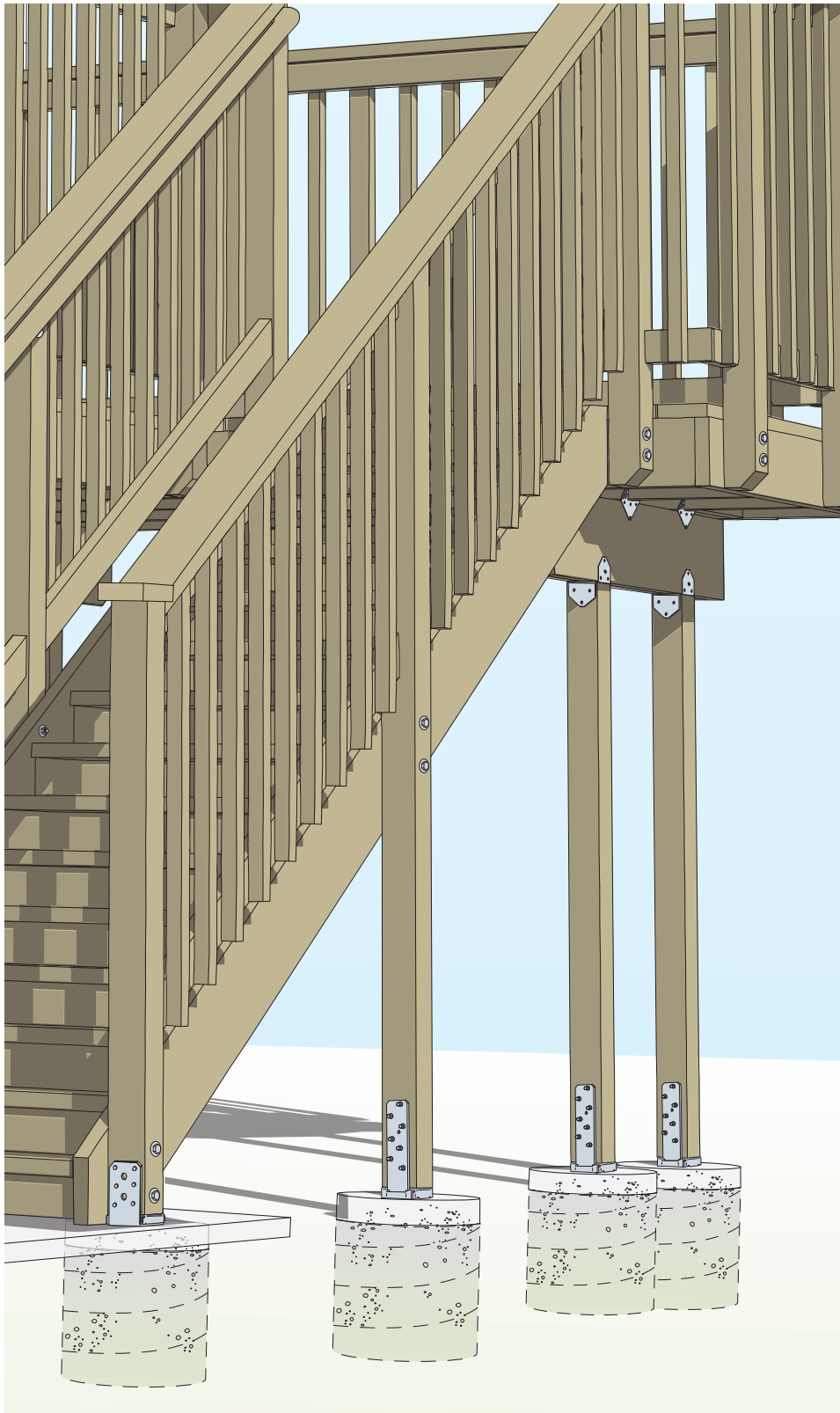

## Building Code Requirements

### Minimum Size

- Minimum size per Table R507.3.1  
*2018/2021 IRC Section R507.3.1*
- Minimum size 12" x 12" or equivalent (14" round)  
*2018/2021 IBC Section 1809.4*

### Depth

- Minimum depth 12" below undisturbed ground. Depth shall extend below frost depth (exceptions for permanent frozen soil and free-standing decks).  
*2018/2021 IRC Section R507.3.2; 2021 IRC Section R507.3.3*  
*2018/2021 IBC Section R1809.4, R1809.5*

### Performance

- Shall support all loads according to Section R301  
*2018/2021 IRC Section R403.1*
- Shall be designed for live, dead, lateral and net-induced uplift forces (wind, seismic, occupant, flood loads)  
*2018/2021 IBC Section 1808*

**Note:** In order to achieve published load values, footings must provide sufficient concrete cover of the embedded portion of Simpson Strong-Tie® cast-in-place post and column bases. In some cases, a footing larger than the minimum required by the building codes will be necessary to meet these requirements. See the Simpson Strong-Tie *Wood Construction Connectors* catalog for more information.

# Post Bases Installed into Concrete

## Building Code Requirements

### Load Resistance

- Columns shall be restrained to prevent lateral displacement at the bottom end. Such lateral restraint shall be provided by manufactured connectors installed in accordance with section R507 and the manufacturer's requirements, or a minimum post embedment of 12 inches in surrounding soils or concrete piers. Wood columns shall not be less in nominal size than 4" x 4".

2018/2021 IRC Section R407.3 and R507.4

2018 IBC Section 2304.10.7  
2021 IBC Section 2304.10.8

- Column and post-end connections shall be fastened to resist lateral and net induced uplift forces.

2018/2021 IRC Section R502.9

2018 IBC Section 2304.10.7  
2021 IBC Section 2304.10.8

Posts must be properly attached to a concrete footing in order to resist lateral and uplift loads. Preservative-treated wood that is cut must be field treated or the post must be elevated off the concrete by 1".

## Simpson Strong-Tie® Solutions

### Cast-in-Place

These products are cast into the concrete at the time of the pour.

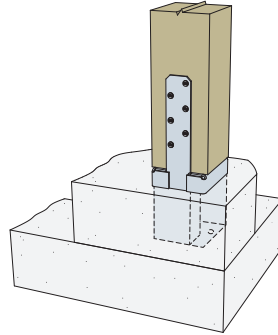

**PPBZ Porch Post Base**  
Features a 1" standoff.  
(features a ZMAX® coating)

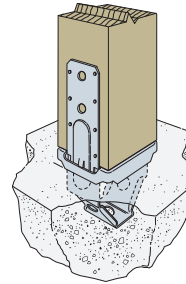

**PBS Post Base with Standoff**  
Features a 1" standoff.  
ZMAX or hot-dip galvanized coating recommended.

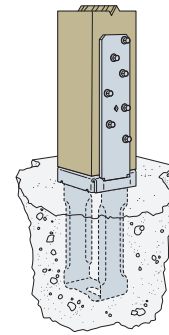

**CBSQ Column Base**  
Installs with Strong-Drive® SDS wood screws and features a 1" standoff. Hot-dip galvanized coating recommended.

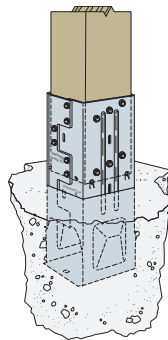

**MPBZ Moment Post Base\***  
Provides moment resistance for wooden columns or posts in free-standing structures. Features 1" standoff tabs.

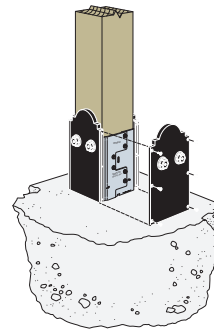

**APBDW Decorative Post Base Wrap**  
Wraps around the MPBZ and matches style of other Outdoor Accents® — Mission Collection® connectors.

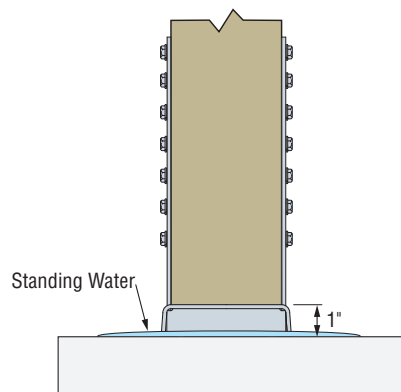

A 1" standoff at the base of the post is required when building with wood that is not preservative treated or decay resistant. The standoff plate raises the post end off the concrete, keeping it drier and reducing the chances of decay. For best long-term results, Simpson Strong-Tie recommends that a base with a standoff be used in exterior/wet applications.

\*May eliminate bracing, contact design professional for additional information.

# Post Bases Installed After the Concrete Hardens

## Simpson Strong-Tie® Solutions

### Post Bases with Anchors

These products utilize anchors installed during the pour or after the concrete hardens.

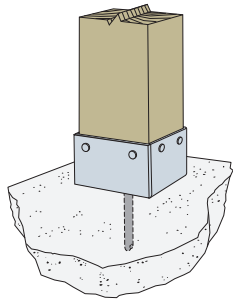

**ABWZ Adjustable Post Base with Standoff**  
(available in ZMAX® coating)

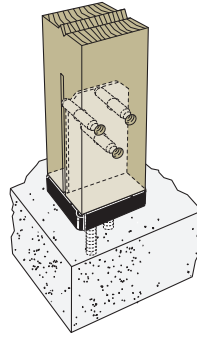

**CPT Concealed Post Tie**  
(available in ZMAX coating and stainless steel)

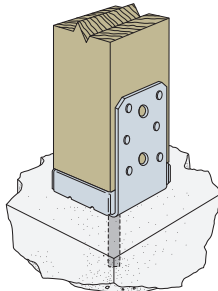

**ABU Adjustable Post Base with Standoff**  
(available in ZMAX coating and stainless steel)

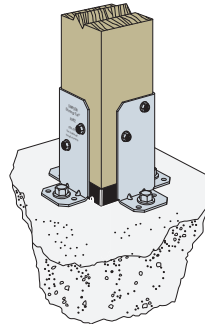

**RPBZ with CPS — Composite Plastic Standoff**  
(available in ZMAX coating)

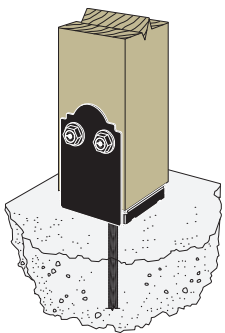

**Outdoor Accents® APB/APVB Post Base**  
ZMAX with black powder coating.

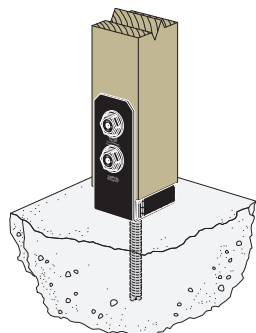

### Building Code Requirements

#### Load Resistance

- Columns shall be restrained to prevent lateral displacement at the bottom end. Such lateral restraint shall be provided by manufactured connectors installed in accordance with section R507 and the manufacturer's requirements, or a minimum post embedment of 12 inches in surrounding soils or concrete piers. Wood columns shall not be less in nominal size than 4" x 4".

2018/2021 IRC Section R407.3 and R507.4

2018 IBC Section 2304.10.7  
2021 IBC Section 2304.10.8

- Column and post-end connections shall be fastened to resist lateral and net induced uplift forces.

2018/2021 IRC Section R502.9

2018 IBC Section 2304.10.7  
2021 IBC Section 2304.10.8

# Post Bases Installed on Existing Concrete

## Post-Installed Anchors

Installing a post base on existing concrete requires the installation of a post-installed anchor to attach the base to the concrete. Simpson Strong-Tie offers a variety of mechanical anchors and anchoring adhesives that are code listed for structural applications.

### Mechanical Anchors:

#### Stainless-Steel Titen HD® Screw Anchor

Provides fast and efficient installation, combined with long-lasting corrosion resistance.

- Available in both Type 316 and Type 304 stainless steel
- For use in cracked and uncracked concrete and masonry
- For use in exterior and most corrosive environments
- Available in 1/4", 3/8", 1/2", 5/8" and 3/4" diameters and multiple lengths (2" to 8 1/2")
- Serrated carbon-steel threads at the cutting tip, minimizing potential corrosion damage to the concrete or masonry

**For more information on anchoring to concrete, go to [strongtie.com](http://strongtie.com) or refer to the following literature:**

- Anchoring ZMAX® post bases with the stainless-steel Titen HD, see L-PBTHDSS

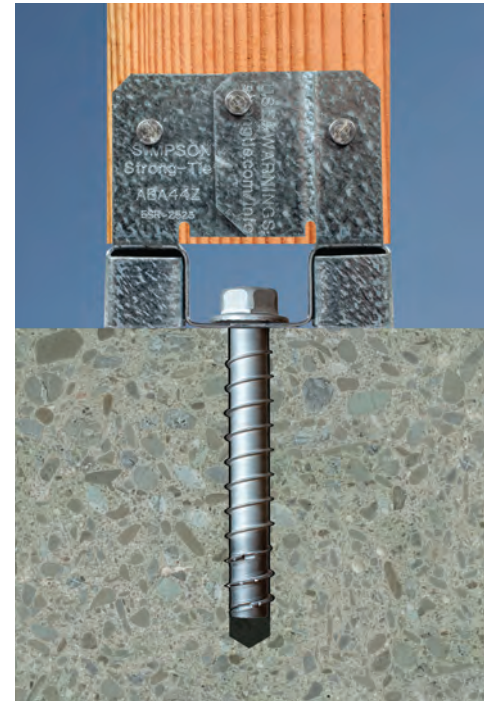

## Anchoring Adhesives

Anchoring adhesives are ideal when maximum strength is needed. These products are available in a variety of cartridge sizes, including convenient single-tube cartridges. Hot-dip galvanized or stainless-steel threaded rod recommended.



**Cracked Concrete CODE LISTED**

**SET-3G™**  
High-Strength Epoxy Adhesive

- For threaded rod and rebar
- Install in dry, water saturated, submerged or water-filled holes in base materials with temperatures between 40°F and 100°F



**Cracked Concrete CODE LISTED**

**SET-XP®**  
High-Strength Epoxy Adhesive

- For threaded rod and rebar
- Install in dry or water-saturated concrete with temperatures between 50°F and 110°F



**Cracked Concrete CODE LISTED**

**AT-XP®**  
High-Strength, Fast-Cure, All-Weather Acrylic Adhesive

- For threaded rod and rebar
- Can be used in cold temperatures as low as 0°F

For more information on these products, see the Simpson Strong-Tie *Anchoring, Fastening, Restoration and Strengthening Systems for Concrete and Masonry* catalog or visit [strongtie.com/anchors](http://strongtie.com/anchors).



# Beam Assemblies and Beam-to-Post Connections

## Multi-Ply Beam Assemblies

For multi-ply beam assemblies, the Strong-Tie® SDWS Framing screw can be used as an alternative to 10d (0.128" x 3") box nails, when installed in the following configuration using 16" o.c. spacing.

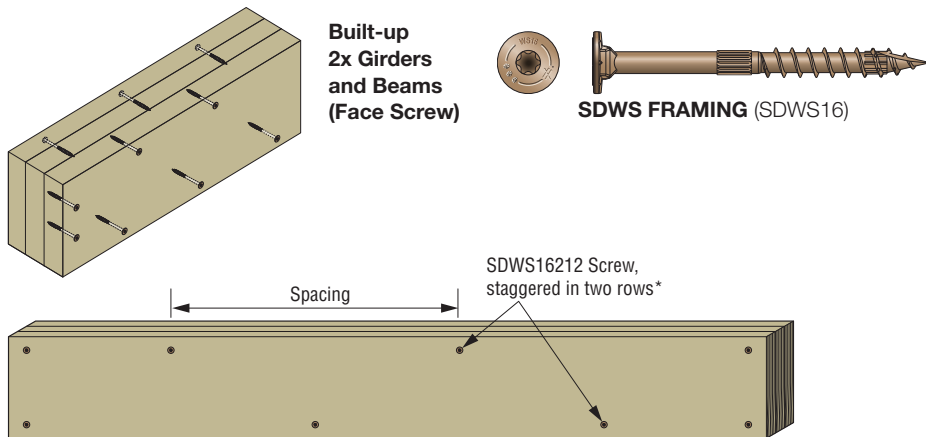

### Beam Assembly Detail\*

\*Fastening pattern shown applies to each ply of the built-up 2x beam.

## Building Code Requirements

- Deck beams shall be fastened together with two rows of 10d (0.128" x 3") box nails minimum at 16" o.c. along each edge.

*IRC 2018/2021 Section R507.5*

*IBC 2018 Section 2304.10.1*

*IBC 2021 Section 2304.10.2*

- Deck beams shall be attached to wood posts in accordance with Figures R507.5.1(1) and R507.5.1(2), or by other equivalent means capable to resist lateral displacement.

*IRC 2018/2021 Section R507.5.2*

## Beam-to-Post Connections

At the point where a beam meets a post, it must be properly connected to the post in order to resist gravity, lateral and uplift loads. This pertains to solid sawn beams or those comprised of multiple members, whether they rest on top or are fastened to the side of the post.

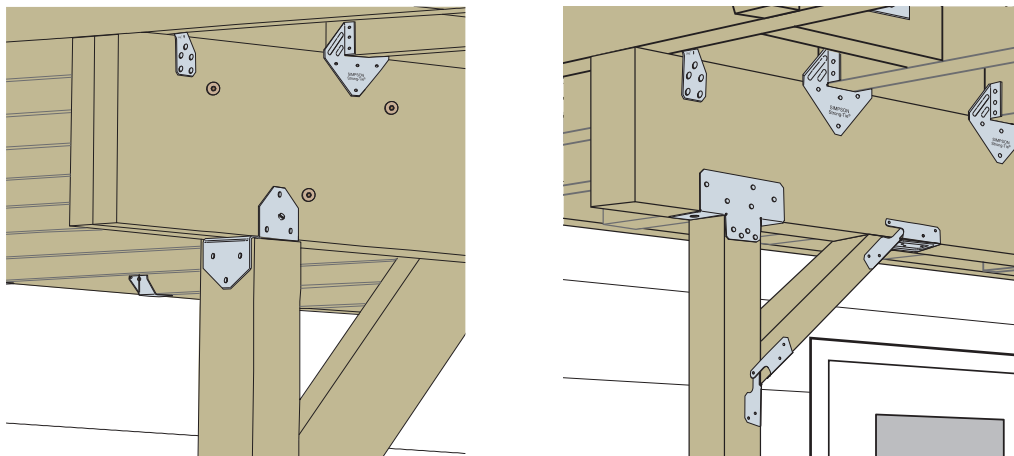

## Simpson Strong-Tie Solutions

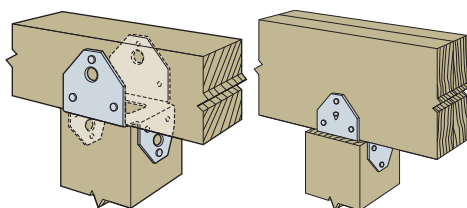

### BC/BCS Post Cap

BC: For single-member solid sawn beams.  
BCS: Connects double 2x's to a 4x post or triple 2x's to a 6x post. ZMAX® coating or stainless steel recommended.

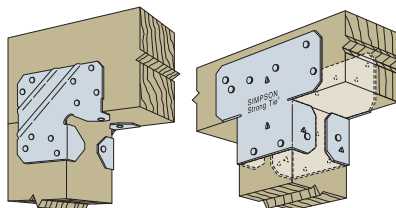

### LCE/AC Post Caps

Two-piece cap should be installed in pairs before or after lumber is in place when the sides of the post and beam are flush. ZMAX coating or stainless steel recommended.

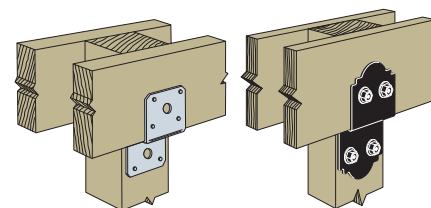

### DJT Deck Joist Tie and Outdoor Accents® APDJT2-6

Deck Joist Tie ZMAX (APDJT with black powder coat).

# Beam-to-Post Connections

## Building Code Requirements

- Deck beams shall be attached to wood posts in accordance with Figures R507.5.1(1) and R507.5.1(2), or by other equivalent means capable to resist lateral displacement.

*IRC 2018/2021 Section R507.5.2*

- Where posts and beam or girder construction is used to support floor framing, positive connections shall be provided to ensure against uplift and lateral displacement.

*IRC 2018/2021 Section R502.9*

*IBC 2018 Section 2304.10.7*

*IBC 2021 Section 2304.10.8*

## Simpson Strong-Tie® Solutions

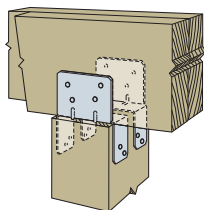

**LPCZ Post Cap**

Two-piece cap adjusts for beams smaller than post width. Features a ZMAX® coating.

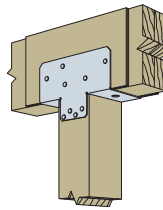

**PCZ/EPCZ Post Caps**

Connects beams at the top of the post. Features ZMAX coating. Installation without shims, similar.

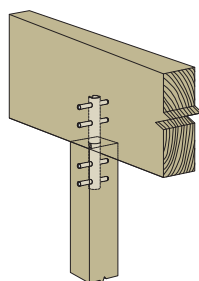
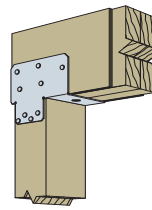

**CBTZ Concealed Beam Tie**

Provides clean look for beam-to-post connections. ZMAX coating.

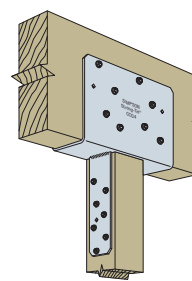

**CCQ/ECCQ Beam-to-Post Connections**

Provides a strong connection for column-beam combinations. (HDG or stainless steel)

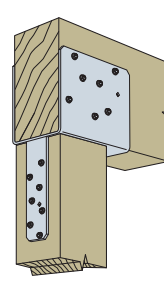

The following are alternative connections for select beam-to-post assemblies.

### Beam-to-Post Connection

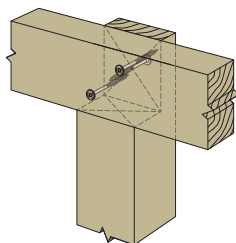

**Beam-to-Notched Post, Non-Spliced**

Uses Strong-Drive® SDWS Timber or Timber SS screws\*

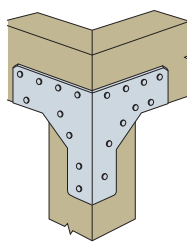

**RTC44Z**

Provides for a mitered beam-to-post corner. ZMAX coating.

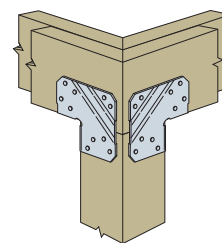

**LCE4**

Provides for a mitered beam-to-post corner. ZMAX coating or stainless steel.

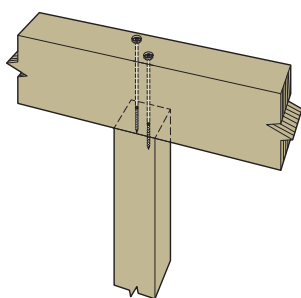

**Continuous Beam over 6x Post**

Uses Strong-Drive SDWS Timber screws

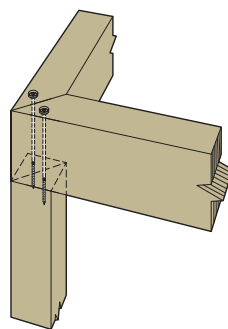

**Mitered Beam over 6x Corner Post**

Uses Strong-Drive SDWS Timber screws

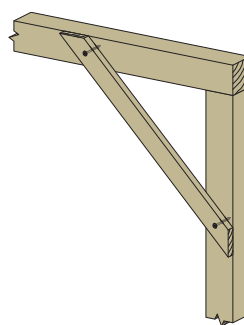

**Alternative Diagonal Bracing**

Uses Strong-Drive SDWS Timber, SDWS Timber SS or SDWH Timber-Hex HDG screws\*

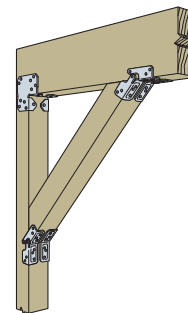

**KBS1Z**

Connects diagonal bracing to beams and columns. ZMAX coating. (If using an MPB, diagonal bracing may not be necessary. Contact a design professional for additional information.)

\*For more information, see engineering letter L-F-DCA6SCREW.

# Ledger Connections

## Vertical Ledger Support at Structures Band/Rim Joist

One of the most common causes for deck failure is ledgers that pull away from the primary structure, resulting in complete collapse.

The Simpson Strong-Tie® Strong-Drive® SDWS Timber, SDWS Timber SS and SDWH Timber-Hex structural wood screws provide an easy-to-install, high-strength alternative to lag screws and through-bolts. They are ideal for securely attaching ledgers to structural wood members and are easier to drive than comparable fasteners. They don't require predrilling like lag screws do and are available in stainless steel or coated for many exterior and preservative-treated wood applications.

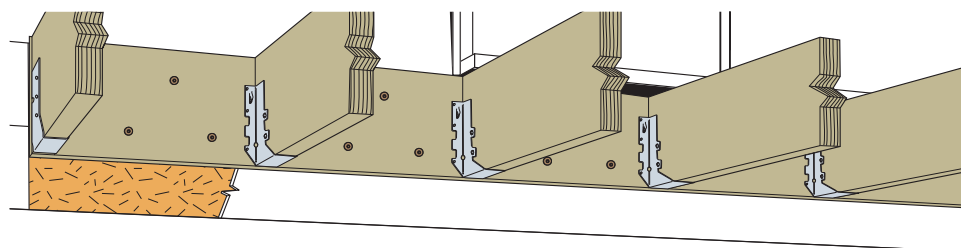

**Ledger may not be installed over siding or stucco. It must be fastened directly to the structural rim board, or fastened to the structural rim board through the sheathing.**

### Strong-Drive Structural Wood Screw

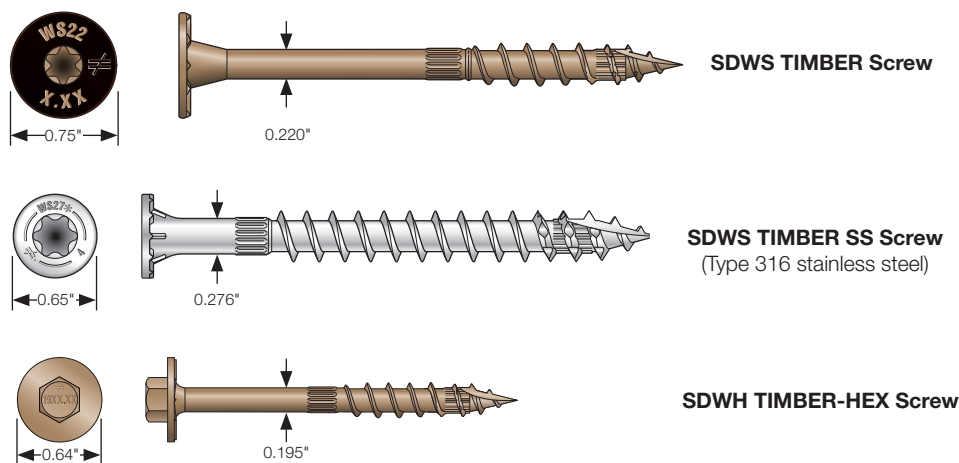

For more information on Strong-Drive screws, refer to p. 38. Additional ledger fastening options include the SDS Heavy-Duty Connector screw and SDWH Timber-Hex HDG screw.

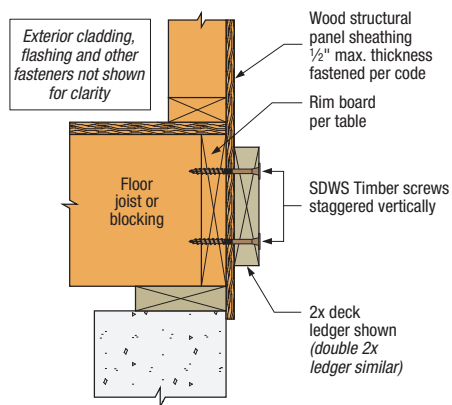

**Ledger-to-Rim Board Assembly**

### Building Code Requirements

- Where supported by attachment to an exterior wall, decks shall be positively anchored to the primary structure and designed for both vertical and lateral loads. Such attachment shall not be accomplished by the use of toenails or nails subject to withdrawal.

IRC 2018/2021 Section R507.8  
IBC 2018/2021 Section 1604.8.3

- Deck ledgers shall not be supported on stone or masonry veneer.

IRC 2018/2021 Section R507.9.1.1

- 1/2" lag screws and 1/2" bolts may be used for a ledger to band joist, to support a live or snow load of 40 psf (IRC 2021 allowing up to a 70 psf snow load) and a dead load of 10 psf.

IRC 2018/2021 Table R507.9.1.3(1)

- Deck ledger connections to band joists shall be in accordance with this section. For other grades, species, connection details and loading conditions, deck ledger connections shall be designed in accordance with IRC Section R301.

IRC 2018/2021 Section R507.9.1

- Vertical and lateral supports at band joist. Vertical and lateral support for decks shall follow this section.

IRC 2018/2021 Section R507.9

Refer to [strongtie.com](http://strongtie.com) and the *Fastening Systems Technical Guide* for more information on fastening ledgers to band joists, as well as the following:

- Ledgers to band joist through foam sheathing
- Ledgers to band joist with a 1/2" gap behind the ledger
- Ledgers to wall studs
- Information for double 2x ledgers

# Ledger Connections

## Vertical Ledger Support at Band Joist Through Brick Veneer

### BVLZ Brick Veneer Ledger Connector

The BVLZ brick veneer ledger connector provides a code-compliant, tested solution for safely adding a deck to an existing house with masonry veneer exterior. It attaches a wood ledger to the framing through the veneer, without loading the veneer as prohibited by the building code. This connector kit provides a viable alternative to building a freestanding deck, and it installs without having to remove or replace large sections of masonry veneer.

The BVLZ brick veneer ledger connector kit includes a steel ledger plate, a compression strut, installation guide (included in 4-pack kit only), two 14" Strong-Drive® SDWH Timber-Hex HDG tension screws and six Strong-Drive SD Connector shear screws. It's designed so the two tension screws pass through the mortar into the structural framing, and the compression strut transfers compression forces from the ledger plate to the rim joist. The system enables the ledger to be supported without bearing on the brick veneer.

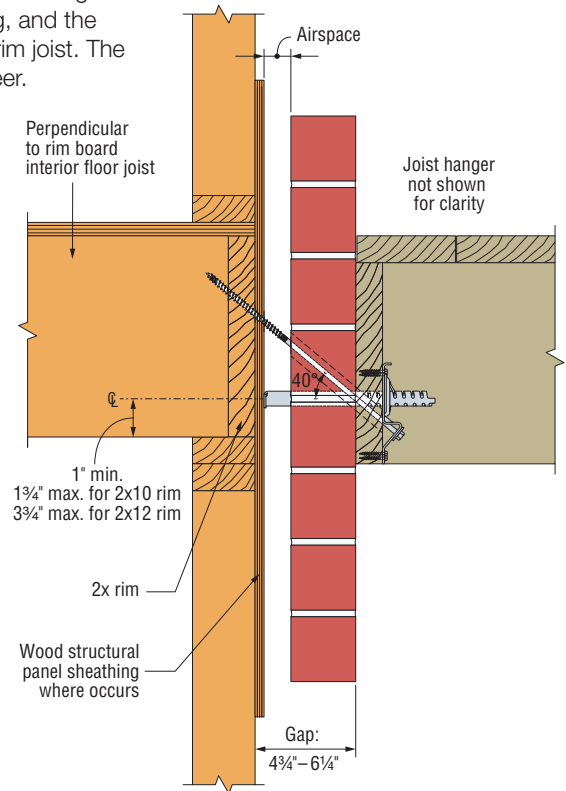
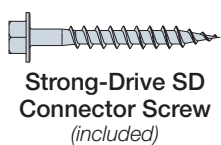
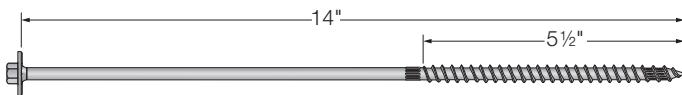
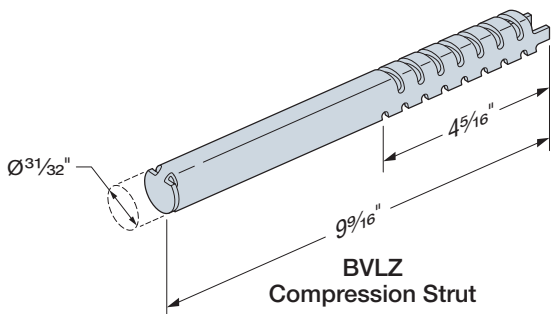
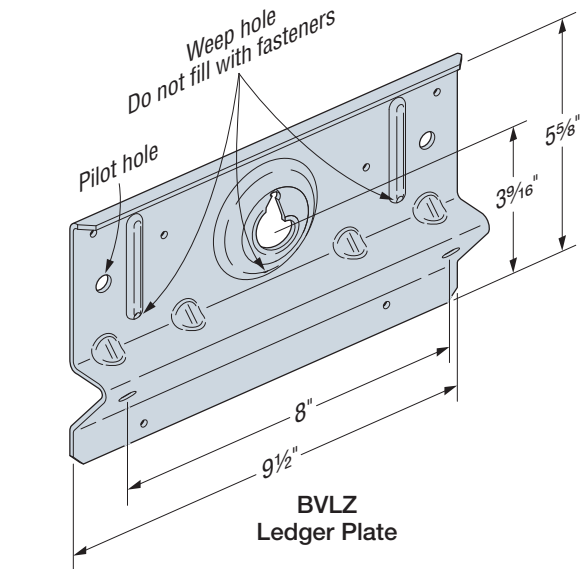

**Typical BVLZ Installation**

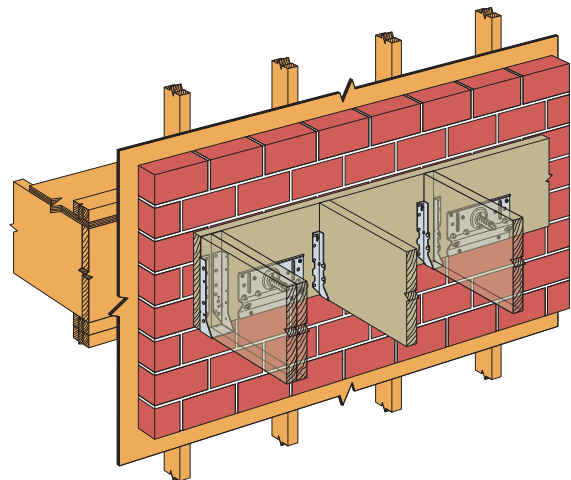

**Typical BVLZ Installation**

For more information on ledger attachment, see *Wood Construction Connectors* catalog or [strongtie.com/bvlz](http://strongtie.com/bvlz).

# Ledger Connections

## Vertical Ledger Support at Concrete or Grout-Filled CMU

### Titen HD® SS Stainless-Steel Anchor

The Simpson Strong-Tie® Stainless Steel Titen HD (THDSS) (see p. 20), may be used to attach a deck ledger (2x8 minimum) to either a concrete or grout-filled concrete masonry unit (GFCMU) wall in accordance with the International Residential Code (IRC). For more information, refer to L-A-THDSSLDGR for concrete walls, and L-A-LDGRGFCMU for GFCMU walls. The anchor is available in either Type 304 or Type 316 stainless steel.

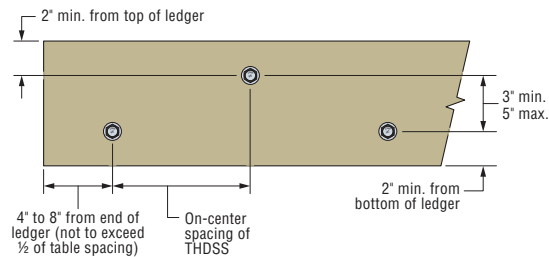
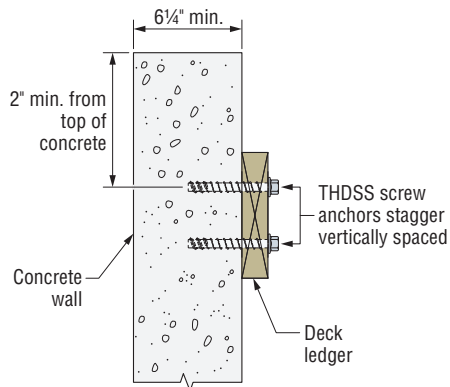

### THDSS Screw Anchor Spacing Detail for Ledgers

Note: Reference L-A-THDSSLDGR for spacing information.

### Ledger-to-Concrete Wall Attachment

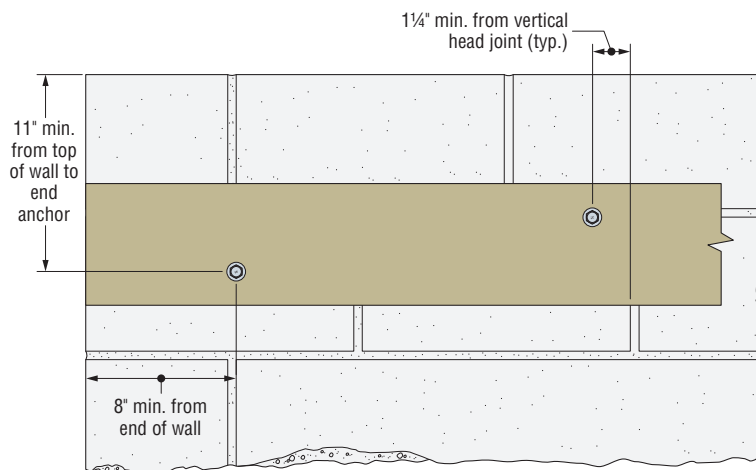
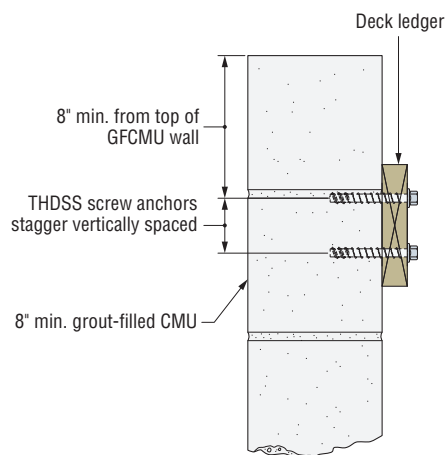

### Ledger-to-GFCMU Wall Attachment (Condition 1)

Note: Reference L-A-LDGRGFCMU for spacing information.

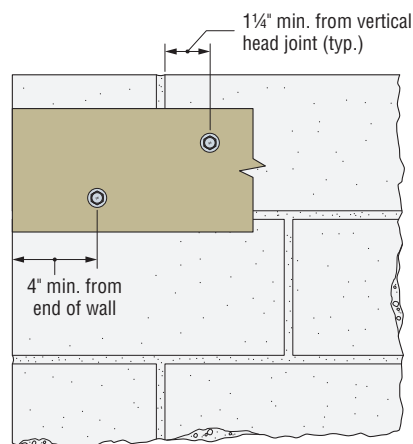
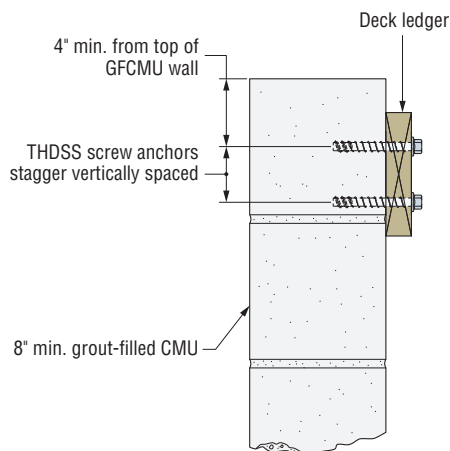

### Ledger-to-GFCMU Wall Attachment (Condition 2)

Note: Reference L-A-LDFRGFCMU for spacing information.



# Lateral Connection to Primary Structure

## Building Code Requirements

- The deck shall be positively anchored to the primary structure and designed for both vertical and lateral loads. Such attachment shall not be accomplished by the use of toenails or nails subject to withdrawal.

*IRC 2018/2021 Section R507.8, R507.9*

- Where the lateral-load connection is permitted to be installed per Figure R507.9.2(1), holdown tension devices shall be installed in not less than two locations per deck, within 24 inches of each end of the deck, and have an allowable stress design capacity not less than 1,500 lb.

*IRC 2018/2021 Section R507.9.2*

- Where the lateral-load connections are provided in accordance with Figure R507.9.2(2), the holdown devices shall be started within 24 inches of each end of the deck and have an allowable stress design capacity of not less than 750 lb. **Note:** a minimum of four holdowns are required evenly distributed along the deck in this configuration.

*IRC 2018/2021 Section R507.9.2*

## Lateral Support at Band Joist

For decks that are partially supported by an adjacent structure (such as a house), the connection between the deck and that structure is vital. A bolted or screwed ledger-to-rim board connection is suitable to support gravity loads; however, in some cases the building codes require a connection that is able to resist lateral loads. In these situations, tension ties are typically called out to tie the joists of the deck directly to the structure.

DTT deck tension ties are a safe, cost-effective solution designed to meet or exceed lateral-load code requirements for deck construction.

DTT1Z satisfies the 2018/2021 IRC provision for a 750 lb. lateral-load connection to the house at four locations per deck. This code detail permits the lateral connection from the deck joists to be made to top plates, studs or headers within the supporting structure.

DTT2 can be used to satisfy the 2018/2021 IRC provision for a 1,500 lb. lateral-load connection at two locations per deck.

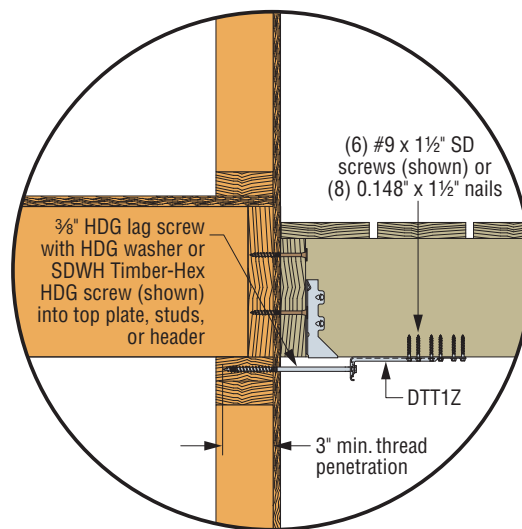

**IRC 2018/2021 Figure R507.9.2(2)**  
**Typical DTT1Z Deck-to-House**  
**Lateral-Load Connection**

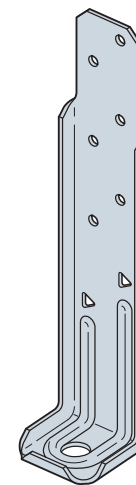

**DTT1Z kit includes**  
**Strong-Drive SDWH**  
**Timber-Hex HDG and**  
**SD Connector Screws**

**DTT1Z Deck Tension Tie**  
US Patent 10,865,588B2

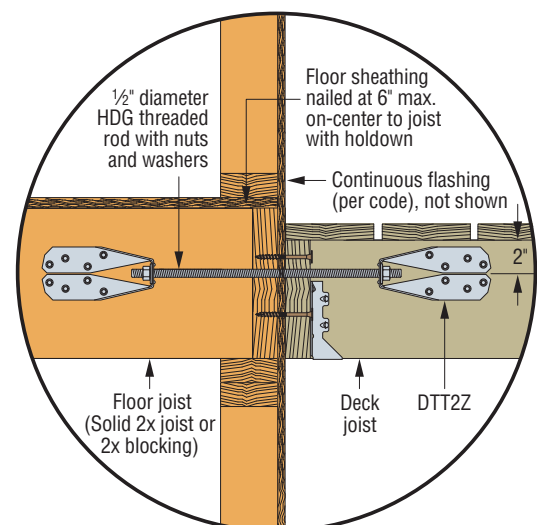

**IRC 2018/2021 Figure R507.9.2(1)**  
**Typical DTT2 Deck-to-House**  
**Lateral-Load Connection**

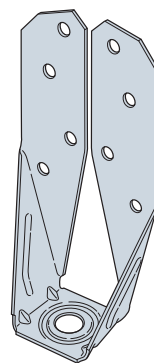

**DTT2 Deck Tension Tie**  
(available in ZMAX® and stainless steel)  
US Patent 8,555,580B2

For more information on lateral-load connections, refer to Simpson Strong-Tie technical bulletin T-C-DECKLAT at [strongtie.com](http://strongtie.com).

# Joists Terminating into Beam/Ledger

When joists terminate into a beam or ledger, a connection is required to provide bearing. The connection must also resist uplift.

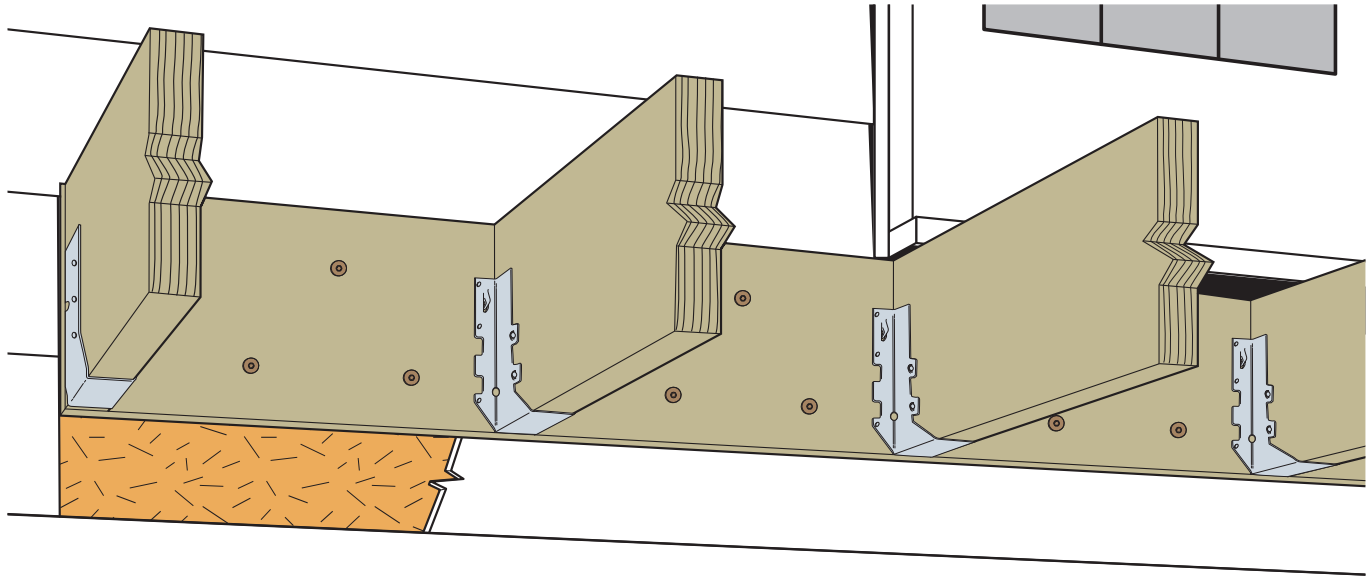

## Simpson Strong-Tie® Solutions

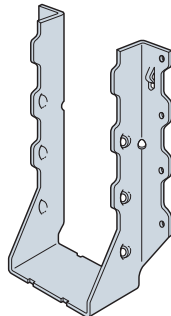
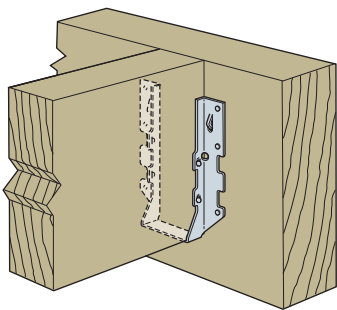

### HUS/LUS Joist Hanger

Provides bearing and uplift resistance, features double-shear nailing for added strength. Available in ZMAX® and Type 316 stainless steel.  
(LUS shown)

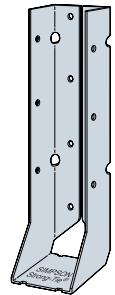
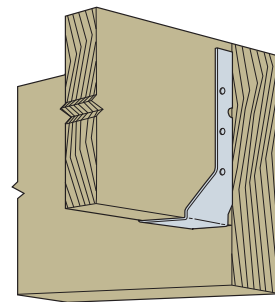

### HUC/LUC Concealed Flange Joist Hanger

Provides bearing and uplift resistance, concealed flanges for cleaner look and for end conditions. Available in ZMAX and Type 316 stainless steel.  
(LUC shown)

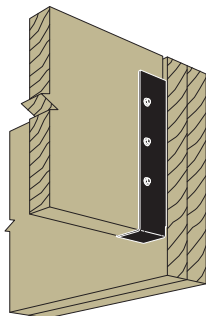

### APLH Outdoor Accents® Light Joist Hanger

Provides bearing and uplift resistance, concealed flanges for cleaner look and end conditions. ZMAX with black powder coating. Uses black SD10112DDBB fasteners.

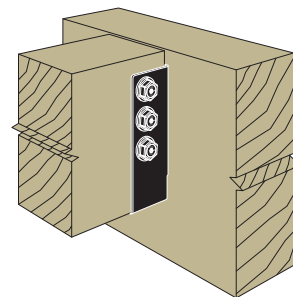

### APHH Outdoor Accents Heavy Joist Hanger

Provides bearing and uplift resistance, concealed flanges for cleaner look and end conditions. ZMAX with black powder coating. Uses STN22 washer and SDWS22312DBB fasteners.

# Joists Terminating into Beam/Ledger

## Building Code Requirements

### Bearing

- The ends of each joist, beam or girder shall have at least 1½" of bearing on wood or metal.

*IRC 2018/2021 Section R507.6.1*

*IBC 2018/2021*

*Section 2308.4.2.2*

- Joists framing into the side of a ledger board or beam shall be supported by approved joist hangers.

*IRC 2018/2021 Section R507.6.1*

### Cantilevered Applications

- Decks with cantilevered framing members, connections to exterior walls or other framing members shall be designed and constructed to resist uplift resulting from the full live load acting on the cantilevered portion of the deck.

*IRC 2018/2021 Section R507.8*

*IBC 2018/2021 Section 1604.8.3*

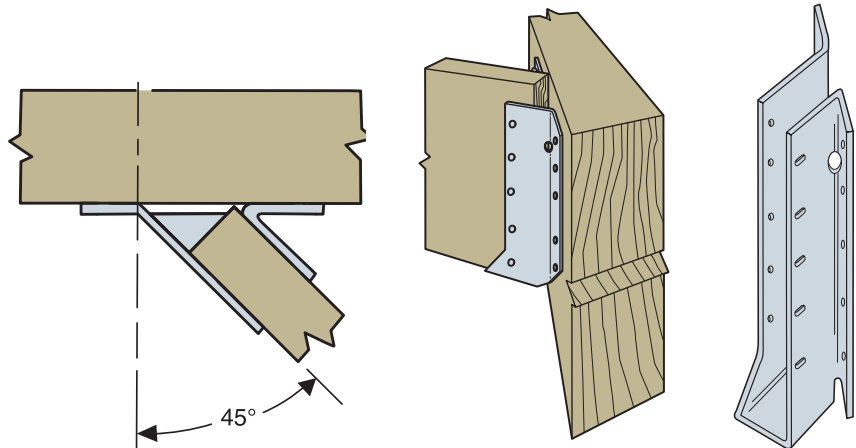

### SUR/SUL Skewed Joist Hanger

45° skewed hanger (available in skewed right and left versions) provides bearing and uplift resistance. ZMAX® coating or stainless steel required.

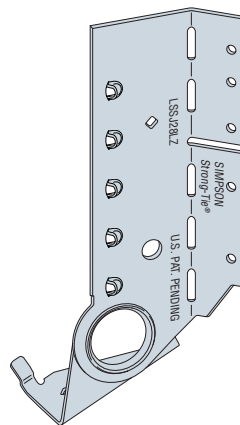

### LSSJZ

LSSJ models are available for single 2x lumber and come in left and right hand versions.

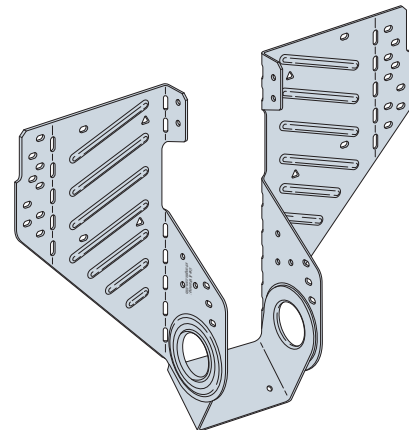

### LSSRZ

LSSR models are available for single 2x and other solid sawn lumber sizes. Patent Pending

### LSSR/LSSJ Field-Skewable Joist Hanger

LSSR field skewable right or left up to 45° (order LSSJ in left or right skews). These hangers provide bearing and uplift resistance. Also field slopeable up or down to 45°. Available with a ZMAX coating.

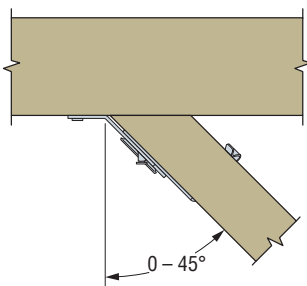

**Typical LSSJRZ Installation**  
(bevel cut required)

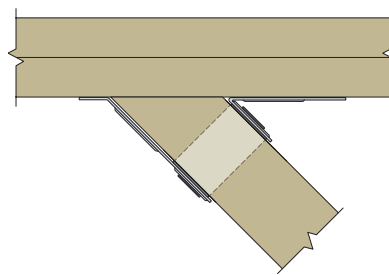

**Typical LSSR Installation**  
(compound miter cut)

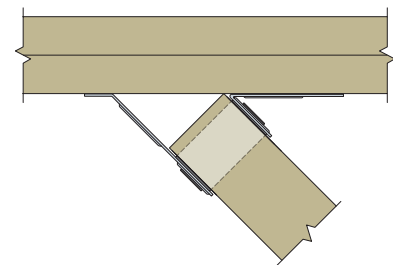

**Alternate LSSR Installation**  
(plumb cut)

# Joists Bearing on a Beam

At the point where the joist bears on top of a beam, there must be a connection to resist lateral and uplift forces. Blocking or framing is also required to prevent rotation of the joists.

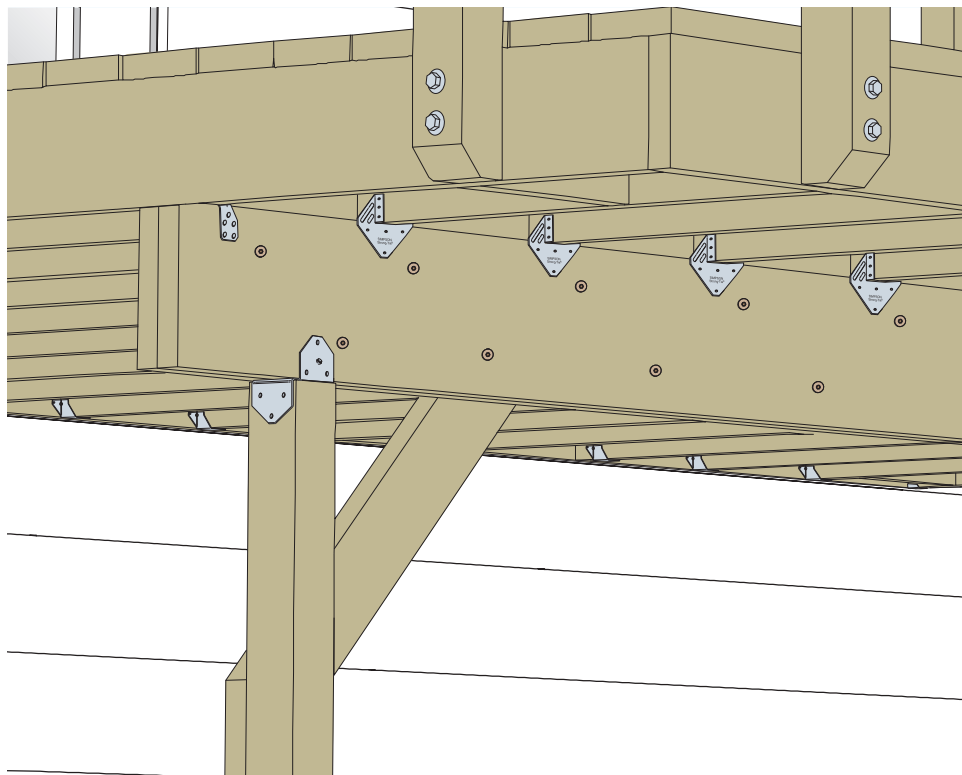

## Building Code Requirements

- Where posts and beam or girder construction is used to support floor framing, positive connections shall be provided to ensure against uplift and lateral displacement.

*IRC 2018/2021 Section R502.9*

*IBC 2018 Section 2304.10.7*

*IBC 2021 Section 2304.10.8*

- Joist ends and bearing locations shall be provided with lateral restraint to prevent rotation.

*IRC 2018/2021 Section R507.6.2*

*IBC 2018/2021*

*Section 2308.4.2.3*

- Joists bearing on top of a single-ply beam or ledger shall be attached by a mechanical connector. Joists bearing on top of a multi-ply beam or ledger shall be fastened in accordance with Table R602.3(1).

*IRC 2018/2021 Section R507.6.1*

## Simpson Strong-Tie® Solutions

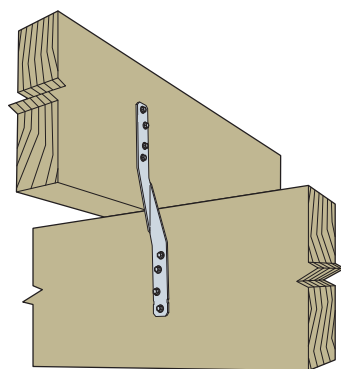

### HTSQ Twist Strap

Designed to resist uplift for decks and beams. Available in ZMAX® and stainless steel. (MTS connector similar)

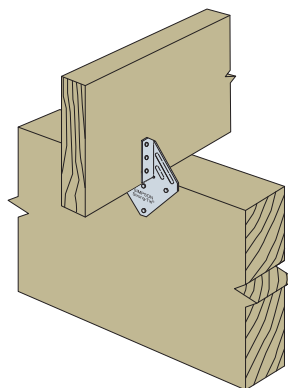

### H1Z Hurricane Tie

Holds joist on both sides. Features ZMAX coating.

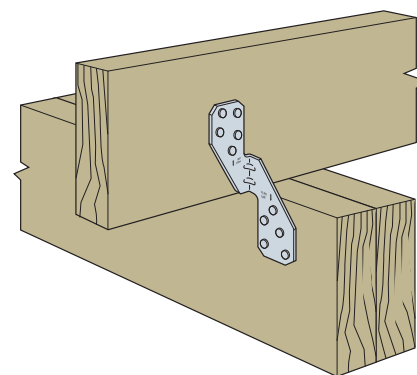

### H2.5A Hurricane Tie

Suitable for single-sided applications. Available in ZMAX and stainless steel.

Simpson Strong-Tie offers a full range of hurricane ties for all types of applications and load requirements. See the Simpson Strong-Tie *Wood Construction Connectors* catalog for more information.



# Guard Post to Deck Framing

The guard post connection is a crucial connection pertaining to deck safety and is often inadequately constructed. In order to provide the required load resistance at the guard, the post must not only be fastened to the rim joist, but also tied back into the joist framing. Machine bolts through the post and rim joist alone do not typically meet the performance requirements of the code. The details on pp. 30–33 have been shown through testing or analysis to resist the required 200 lb. concentrated load (or load of 50 lb. per linear foot per IBC when guardrail spacings do not exceed 48") applied in an outward direction for maximum guard heights of 36" and 42" above the deck surface.

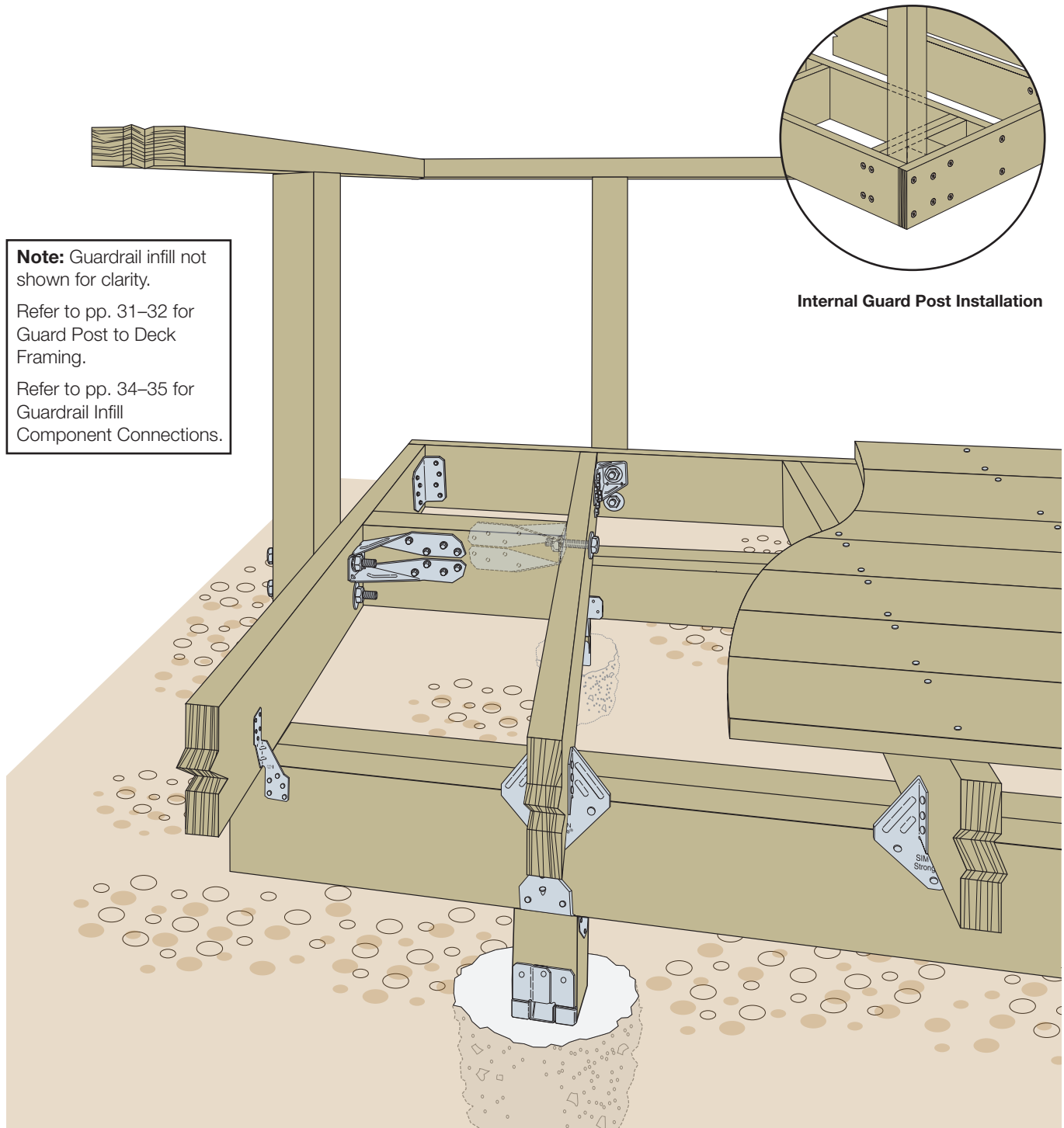

**Note:** Guardrail infill not shown for clarity.  
Refer to pp. 31–32 for Guard Post to Deck Framing.  
Refer to pp. 34–35 for Guardrail Infill Component Connections.

**Internal Guard Post Installation**

For more information on this application, see Simpson Strong-Tie technical bulletin T-C-GRDRLPST.

# Guard Post to Deck Framing – Holdown Details

## Simpson Strong-Tie® Solutions For 36"-Tall Guard Posts

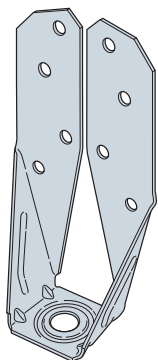

**DTT2 Deck Tension Tie**  
(available with ZMAX® coating or in stainless steel, includes SDS Heavy-Duty Connector screws)  
US Patent 8,555,580B2



**SDS Heavy-Duty Connector Screw**

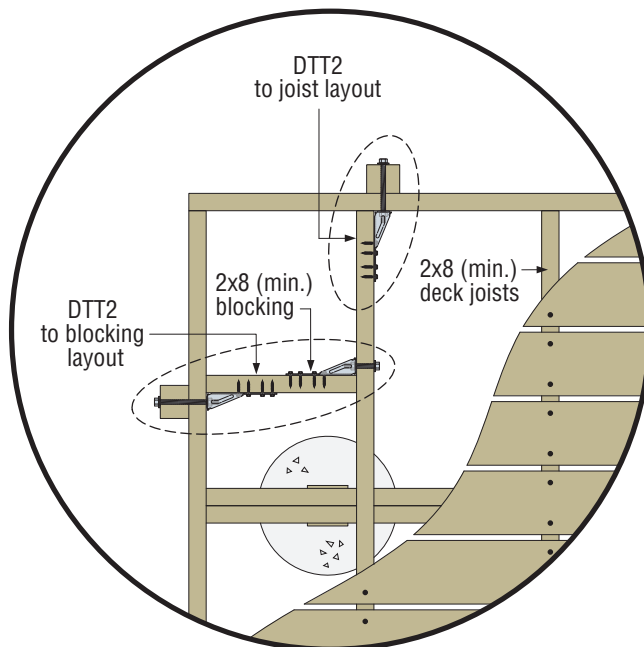

**DTT2 Attachment of Guardrail Post Outside Rim/Joist**

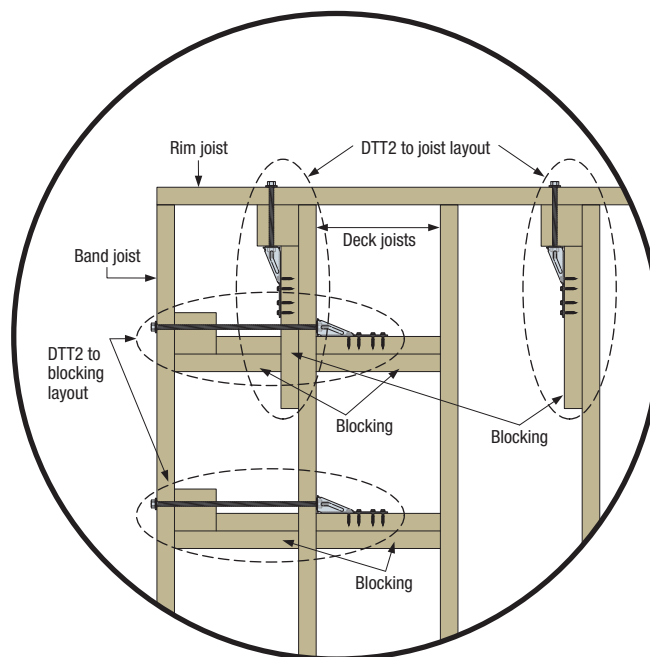

**DTT2 Attachment of Guardrail Post Inside Rim/Joist**

### Building Code Requirements

#### When required

- Guards shall be located along open-sided walking surfaces, including floors, stairs, ramps and landings, that are located more than 30" measured vertically to the floor or grade below at any point within 36" horizontally to the edge of the open side.

*IRC 2018/2021 Section R312.1.1  
IBC 2018/2021 Section 1015.2*

#### Height

- Guards shall be a minimum of 36" tall (IRC) or up to 42" tall for certain occupancies (IBC).

*IRC 2018/2021 Section R312.1.2  
IBC 2018/2021 Section 1015.3*

#### Load Resistance

- Guards and handrails shall be able to resist a single concentrated load of 200 lb., applied in any direction at any point along the top. (IRC 2021 simplifies the load direction to downward and horizontally outward for the top of a guard not required to serve as a handrail).

*IRC 2018/2021 Table R301.5  
IBC 2018 Section 1607.8.1.1  
IBC 2021 Section 1607.9.1.1*

- Handrails and guards shall be designed to resist a load of 50 lb. per linear foot.

*IBC 2018 Section 1607.8.1  
IBC 2021 Section 1607.9.1  
(not required for one- and two-family dwellings)*

- Guardrail infill components shall withstand a horizontal load of 50 lb. over an area of one square foot.

*IRC 2018/2021 Table R301.5  
IBC 2018 Section 1607.8.1.2  
IBC 2021 Section 1607.9.1.2*

#### Opening Limitations

- Required guardrail infill shall not have an opening that allows passage of a sphere 4" in diameter.

*IRC 2018/2021 Section R312.1.3  
IBC 2018/2021 Section 1015.4*

For more information on connecting posts inside the rim joist using the DTT2 or HTT4, see Simpson Strong-Tie technical bulletin T-C-GRDRLPST.

# Guard Post to Deck Framing – Holdown Details

## For 42"-Tall (maximum) Guard Posts

Note: The DTT2 may also be used to secure 42" guard posts with 2x10 (min.) deck joists.

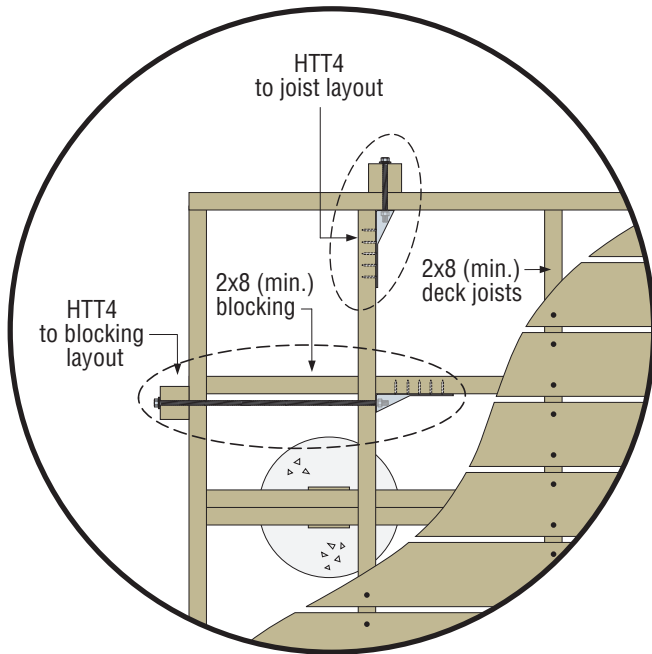

**HTT4 Attachment of Guardrail**  
Post *Outside* Rim/Joist

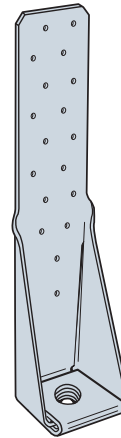

**HTT4 Tension Tie**  
Also available with hot-dip galvanized coating.



**Strong-Drive® SD Connector Screw**

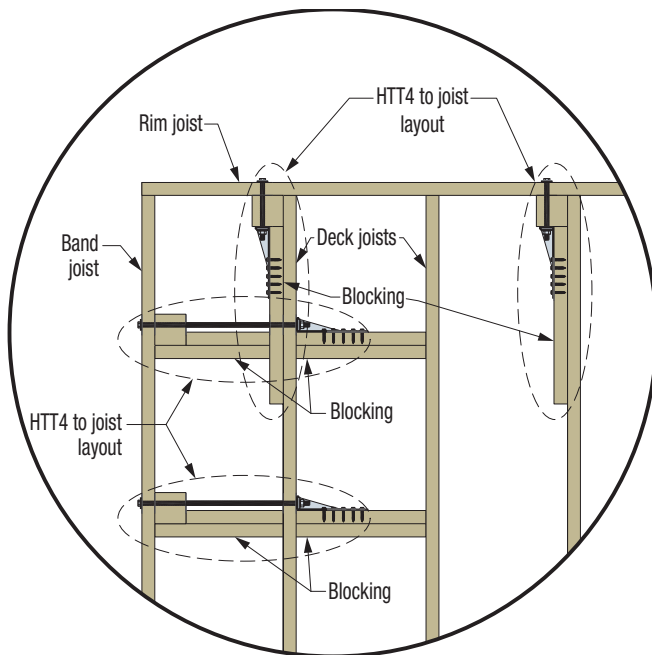

**HTT4 Attachment of Guardrail**  
Post *Inside* Rim/Joist  
(not all fastening for joists and blocking shown for clarity)



**ATR All Threaded Rod/  
RFB Retrofit Bolt**  
Available with hot-dip galvanized coating  
or in Type 316 stainless steel.

For more information on connecting posts inside the rim joist using the DTT2 or HTT4, see Simpson Strong-Tie technical bulletin T-C-GRDRLPST.

# Guard Post to Deck Framing – Fastener Details

## For 36"- and 42"-Tall Guard Posts

As an alternative code-compliant solution for attaching wood guard posts without the use of typical hardware and through-bolts, the guard posts and the framing elements can be fastened with Strong-Drive® SDWS Timber screws. The SDWS Timber screws are code report listed in IAPMO UES ER-192. The solutions below have been tested and verified for 36"-tall guard posts constructed with DFL, HF and SP framing. These solutions have also been tested and verified for 42"-tall guard posts constructed with DFL and SP framing only. For more information, please refer to *Fastening Systems Technical Guide*.



**Strong-Drive SDWS TIMBER Screw**

(5": SDWS22500DB, 8": SDWS22800DB) US Patent 9,523,383

**Note:** For this installation, only SDWS22500DB and SDWS22800DB fasteners are to be used and installed per Simpson Strong-Tie details. Test results have shown that generic fasteners do not provide sufficient withdrawal resistance, pull-through resistance or shear strength.

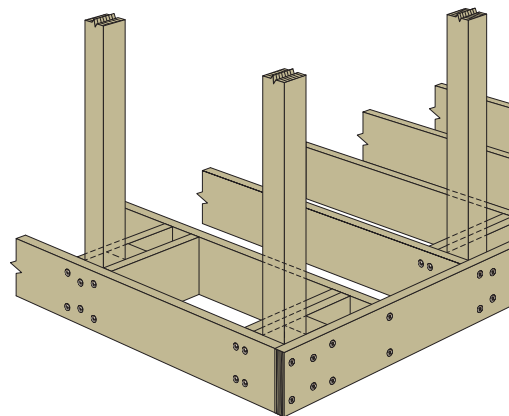

**Internal Guard Post Installations Using Strong-Drive SDWS Timber Screws**

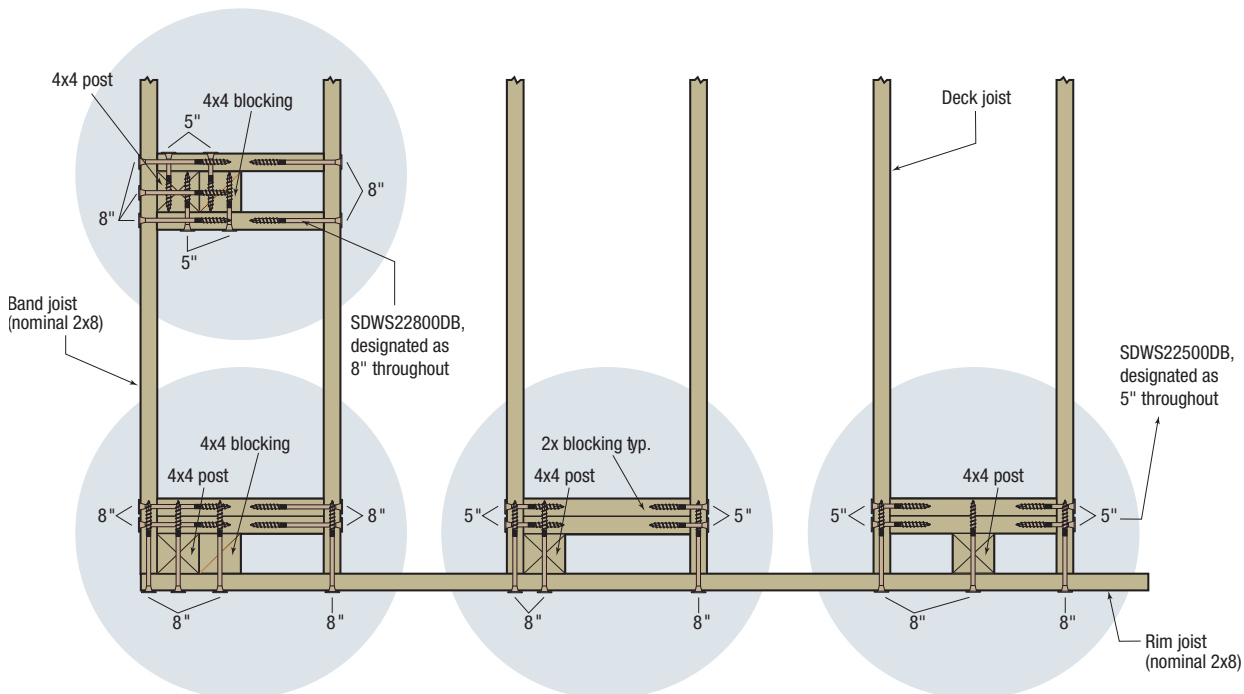

**Plan View Showing Details of Four Connections Using Strong-Drive SDWS Timber Screws**

(other connection hardware not shown for clarity)



# Guardrail Infill Component Connections

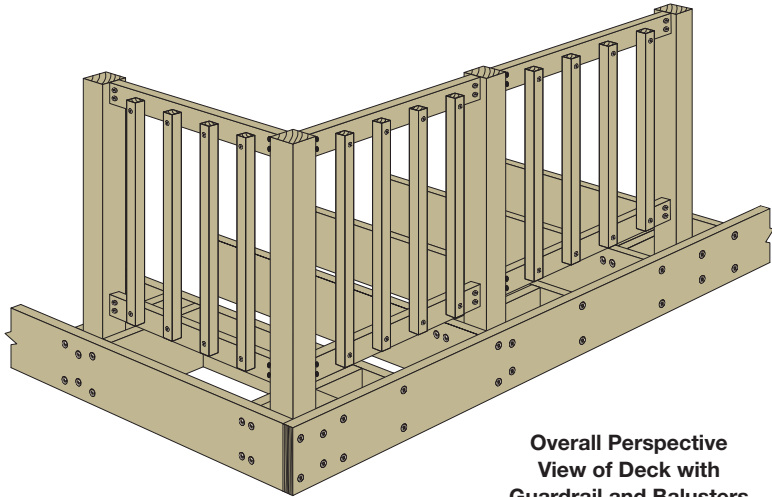

IRC code-compliant fastener solutions for guardrail-to-post and baluster-to-rail assemblies use Strong-Drive® SDWS Framing screws, Deck-Drive™ DSV Wood screws and Deck-Drive DWP Wood SS screws, as described in this section. The indicated fastening does not replace the required connections to rim or ledger. For more information, please refer to *Fastening Systems Technical Guide*.

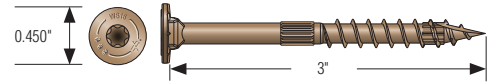

**Strong-Drive SDWS FRAMING Screw**  
US Patent 9,523,383

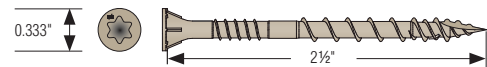

**Deck-Drive DSV WOOD Screw**

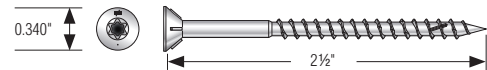

**Deck-Drive DWP WOOD SS Screw**

## Guardrail Installations IRC Code-Compliant Guardrail Connection Details

### Installation scope:

- Maximum guard post spacing of 6'
- Nominal lumber 2x4 top and bottom guardrail (AWC)
- Nominal lumber 4x4 guard post
- SPF, HF, DF, or SP lumber wood species for 36" guard post
- DF or SP lumber wood species for 42" guard post

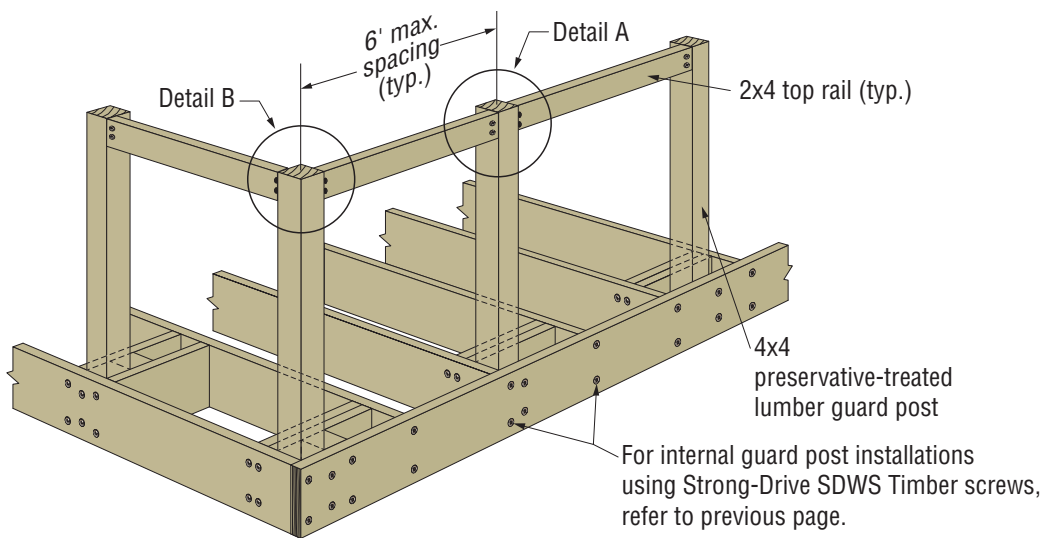

**Overall Perspective View of Deck**

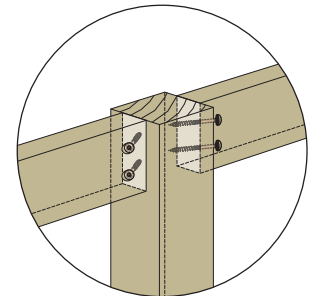

**Detail A: Rail-to-Post Perspective View**

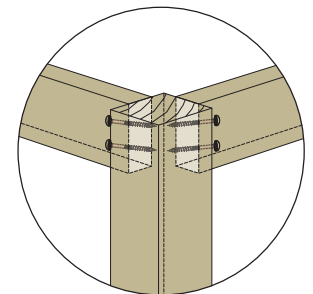

**Detail B: Perspective View**

# Guardrail Infill Component Connections

## Baluster Installations

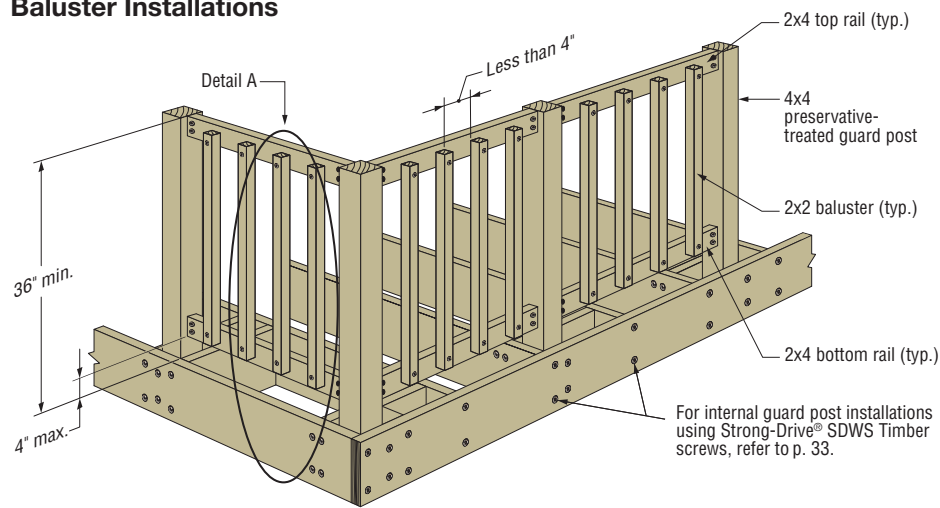

**Overall Perspective View of Deck with Baluster Detail**

### Building Code Requirements

#### Load Resistance

- Guardrail infill components shall withstand a horizontal load of 50 lb. over an area of one square foot.

IRC 2018/2021 Table R301.5  
IBC 2018 Section 1607.8.1.2  
IBC 2021 Section 1607.9.1.2

#### Opening Limitations

- Required guardrail infill shall not have an opening that allows passage of a sphere 4" in diameter.

IRC 2018/2021 Section R312.1.3  
IBC 2018/2021 Section 1015.4

## Code-Compliant Baluster Connection Details

### Installation scope:

- Maximum guard post spacing of 6'
- Nominal 2x4 top and bottom guardrail (AWC)
- Nominal lumber 4x4 guard post
- SPF, HF, DF, or SP lumber wood species for 36" guard post
- DF or SP lumber wood species for 42" guard post

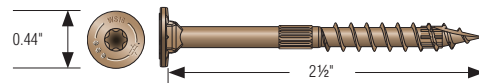

**Strong-Drive SDWS FRAMING Screw**  
US Patent 9,523,383

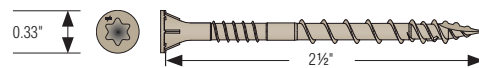

**Deck-Drive™ DSV WOOD Screw**

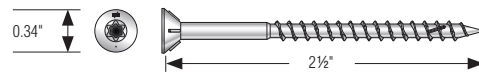

**Deck-Drive DWP WOOD SS Screw**

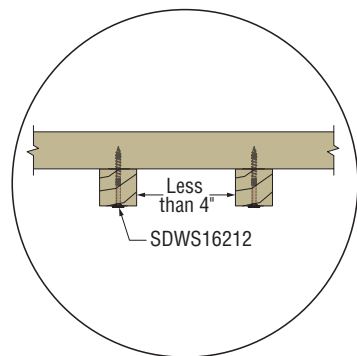

**Detail A: Baluster Plan View**  
(SDWS16212 listed, DSVT212, S08250WP similar)

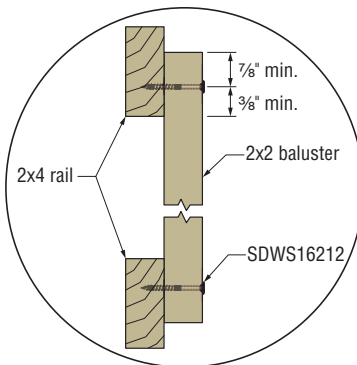

**Detail A: Baluster Elevation View (Side)**  
(SDWS16212 listed, DSVT212, S08250WP similar)

- Fasten screws into 2x2 baluster, on center, 7/8" from each end of baluster into 2x4 top and bottom rails with SDWS16212 screws.

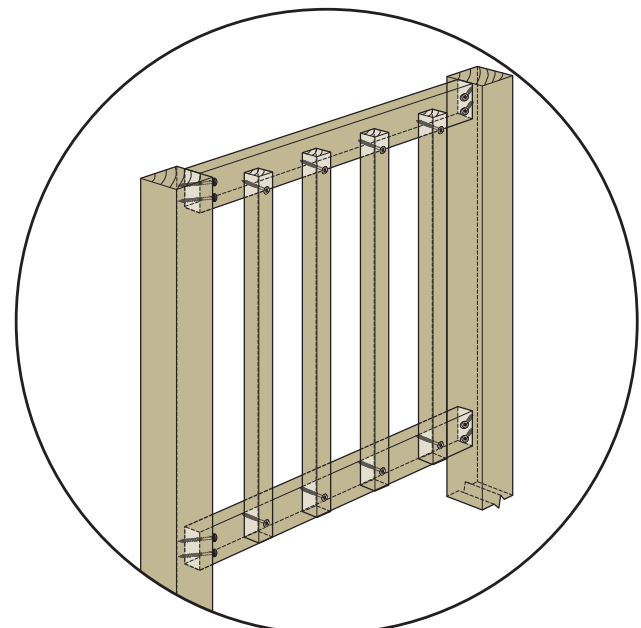

**Baluster Perspective View**

# Stair Stringers and Treads

## Building Code Requirements

### Stair Stringer to Rim Joist

- Stairs must be able to resist 40 lb. per square foot of tread area in one and two family dwellings. All other stairs under IBC require a design to 1.5 times the live load for the area served, not to exceed 100 psf.

IRC 2018/2021 Table R301.5  
IBC 2018/2021 Table 1607.1

### Stair Tread to Stringer

- Individual stair treads shall be able to resist a 300 lb. concentrated load acting over an area of 2" x 2".

IRC 2018/2021 Table R301.5  
IBC 2018 Table 1607.1  
IBC 2021 Table 1607.1  
Section 1607.21

### Guard Opening Limitations

- The triangular opening formed by the riser, tread and bottom rail of a guard at the open side of a stairway shall be of such a size that a sphere 6" in diameter cannot pass through.

IRC 2018/2021 Section R312.1.3  
IBC 2018/2021 Section 1015.4

Additional Exception: Openings for required guards on the open side of stairs shall not allow a sphere 4<sup>3</sup>/<sub>8</sub>" in diameter to pass through. For IBC, exception is only valid for individual dwelling units in Group R-2 and R-3 occupancies.

IRC 2018/2021 Section R312.1.3  
ICB 2018/2021 Section 1015.4

Stair stringers must be properly connected to the deck, and treads properly connected to the stringers, in order to resist loads. In addition, code requirements regarding openings between stair treads and stair railing must also be met.

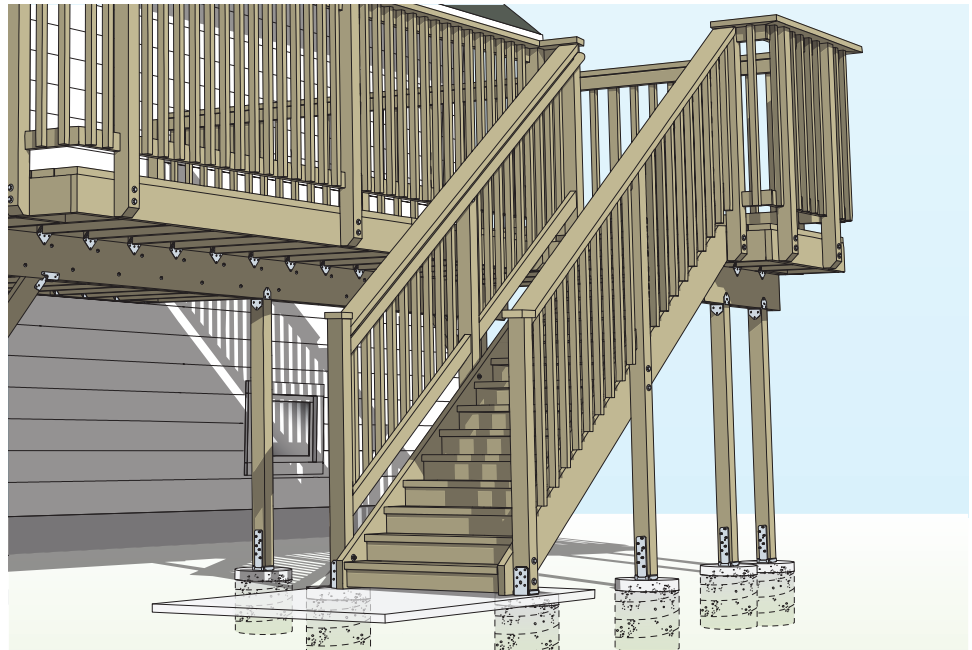

## Simpson Strong-Tie® Solutions

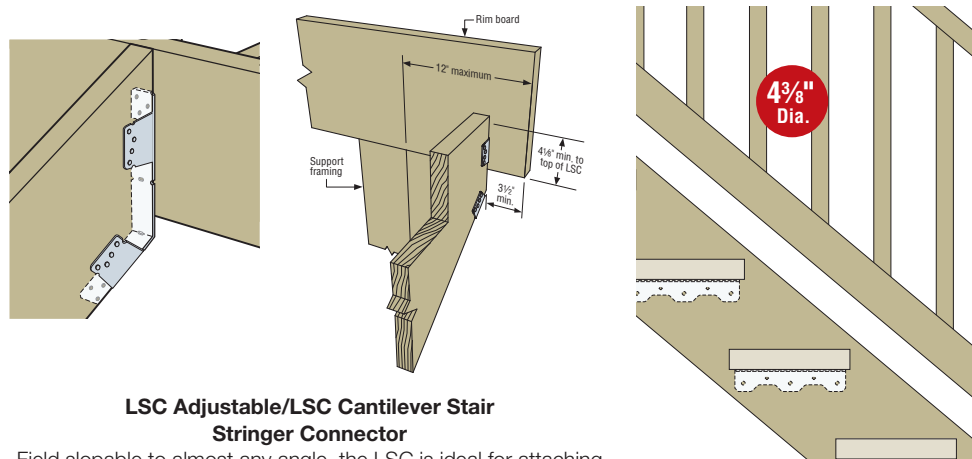

### LSC Adjustable/LSC Cantilever Stair Stringer Connector

Field slopable to almost any angle, the LSC is ideal for attaching the staircase stringer to the deck. Suitable for solid and notched stringers. Available in ZMAX® and Type 316 stainless steel. For information regarding notched stringer attachment to full-width stringers, see L-F-DCA6SCREW.

Codes require that a 4<sup>3</sup>/<sub>8</sub>" sphere must not be able to pass between any guard opening at stairs.

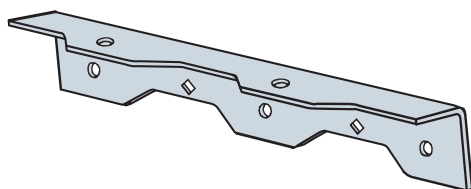

**SDS Heavy-Duty Connector Screw**  
(Included in TA9ZKT and TA10ZKT kits)

**TA Tread Angle**  
Provides a positive connection, eliminating the need to notch the stringer. A full-width stringer is stronger and makes it easier to meet maximum guardrail opening requirements of the codes. ZMAX coating or stainless steel required.

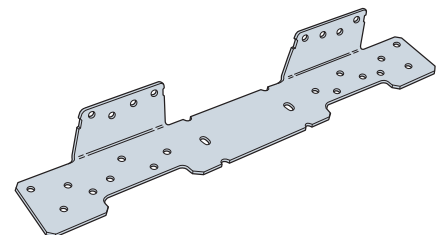

**LSCZ/LSCSS**

# Performance Fasteners for Decks



# Structural Wood Fastening

## Structural Wood-to-Wood and Engineered Wood Connections

Simpson Strong-Tie® Strong-Drive® structural screws make high-strength wood-to-wood and engineered wood connections easier and stronger. Designed for both ease of installation and superior strength, these versatile screws are a time-saving alternative to multiple smaller fasteners, lag screws or bolts that require predrilling.

### Strong-Drive SDWS FRAMING, SDWS TIMBER and SDWH TIMBER-HEX Structural Wood Screw

The Simpson Strong-Tie Strong-Drive SDWS Timber, SDWH Timber-Hex and SDWH Timber-Hex HDG wood screws are designed to provide an easy-to-install, high-strength alternative to through-bolting and traditional lag screws. These structural screws are ideal for the contractor and do-it-yourselfer alike, and are available in materials and coatings for various levels of corrosion resistance to match your installation environment.

#### Features:

- Bold thread design that provides superior holding power
- Quik Guard®, double-barrier coating (SDWS and SDWH) and hot-dip galvanized (SDWH HDG)
- Large washer head provides maximum bearing area
- Patented SawTooth® points (US Patent 9,523,383) that ensure fast starts, reduce installation torque and eliminate the need for predrilling in most applications
- Underhead nibs that offer greater installer control when seating the head

Codes/Standards: IAPMO UES ER-192



**SDWS TIMBER (SDWS22)**



**SDWH TIMBER-HEX HDG (SDWH27HDG)**

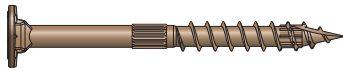

**SDWS FRAMING (SDWS16)**



**SDWH TIMBER-HEX (SDWH19)**

### Strong-Drive SDWS TIMBER SS Screw

The Strong-Drive SDWS Timber SS structural fastener, in severe corrosion-resistant Type 316 stainless steel, has a 0.276"-diameter shank, SawTooth point and flat washer head, and is designed as a lag screw replacement in applications where severe corrosion resistance is critical.

#### Features:

- Patented SawTooth point for fast starts and less driving torque — without predrilling
- Large 0.650"-diameter flat washer head with nibs provides load-bearing area and seats flush with surface
- Deep T50, 6-lobe recess for secure driving
- Type 316 stainless steel provides corrosion resistance even in severe conditions
- Mid-shaft knurl aids in torque reduction

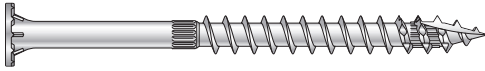

**SDWS SS (SDWS27SS)**

## Structural Connector Screws

### Strong-Drive SDS HEAVY-DUTY CONNECTOR Screw

The Simpson Strong-Tie Strong-Drive SDS Heavy-Duty Connector screw is a 1/4"-diameter high-strength structural screw ideal for various connector installations as well as wood-to-wood and engineered wood applications.

#### Features:

- Available with a double-barrier coating or in Type 316 stainless steel
- Double-barrier coating provides corrosion resistance equivalent to hot-dip galvanization
- Type 17 points enable easy driving with no predrilling and minimal splitting
- Head is stamped with the Simpson Strong-Tie "≠" sign and fastener length for easy identification after installation

Codes/Standards: ICC-ES ESR-2236

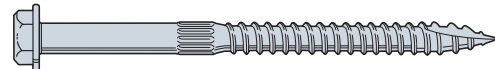

**SDS Double-barrier (SDS25)**



**SDS SS (SDS25SS)**

### Strong-Drive SD CONNECTOR Screw

Strong-Drive SD Connector and SD Connector SS Screws. These #9 and #10 hex-head fasteners are available in 1 1/2" and 2 1/2" lengths for various connector installations and can replace 10d and 16d common nails. Please see the *Fastening Systems Technical Guide* for a list of connectors approved for use with the SD Connector screws.

#### Features:

- Available in mechanically-galvanized coating and Type 316 stainless steel
- Tested and approved for use in many Simpson Strong-Tie connectors



**SD Mechanically Galvanized (SD925)**



**SD SS (SD925SS)**

# Screws for Decking

Simpson Strong-Tie offers a variety of premium solutions for fastening wood, PVC or composite decking. Our fasteners are designed specifically to perform in their target decking material, and many of our fasteners are available in colors to provide a fastening solution that blends with the deck surface.

## Stainless-Steel Screws

### Deck-Drive™ DWP WOOD SS Screw

For the majority of wood deck boards (#8, 9 and 10 sizes)

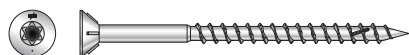

### Strong-Drive® DWP WOOD SS Screw

For structural applications on decks (#12 and #14 sizes)



### Bugle-Head Wood Screw

For all types of wood decking including cedar, redwood and preservative-treated woods (non-hardwood). Bugle-Head Wood screws are available in both square and 6-lobe drive recesses.



## Exterior-Grade Screws

### Deck-Drive DSV WOOD Screw

For preservative-treated wood. US Patent 9,482,258



### Trim-Head Screw — 6-Lobe Drive

For wood decking and PVC decking materials

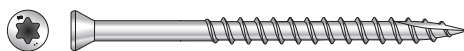

### Deck-Drive DCU COMPOSITE SS Screw

For composite decking

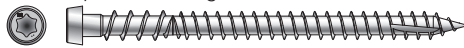

Also available with color-matching painted heads

### Deck-Drive DHPD HARDWOOD Screw

For hardwood decking materials

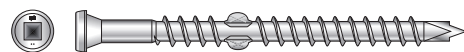

### Deck-Drive DCU COMPOSITE Screw

For composite decking

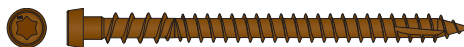

Available in a variety of color-matching painted options. See p. 40.

## Load-Rated Deck Board Fasteners

### Strong-Drive DWP WOOD SS Screw

Sizes: #10, #12 and #14. For wood in high and severe corrosion environments. See *Fastening Systems Technical Guide* for more information.

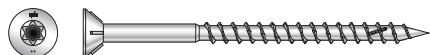

### Deck-Drive DCU COMPOSITE Screw

For composite/PVC decking. For more information, see L-F-DCUULIFT.

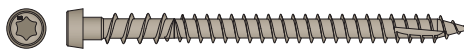

Available in a variety of color-matching painted options. See p. 40.

### Deck-Drive DSV WOOD Screw

Size: #10. For preservative-treated decking applications in medium corrosion environments. For more information, see L-F-DSVCSV21. US Patent 9,482,258



## Building Code Requirements

- Wood decking shall be attached to each supporting member with not less than (2) 8d threaded nails or (2) No. 8 wood screws.

IRC 2018/2021 Section R507.7

Experience has shown that #7 stainless steel screws are acceptable for face screw fastening of wood and composite deck boards.

### Fastening for composite decking or using concealed fasteners:

IRC 2018/2021 Section R507.2.2.5  
IBC 2018/2021 Section 2612.6

Wood Plastic Composite deck boards shall be installed in accordance with the manufacturer's instructions and shall comply with the requirements of ASTM D7032 Section 5.5 Mechanical Fastener Holding Tests for the use of concealed clips. Simpson Strong-Tie recommends consulting with the decking manufacturer for their recommendations.

316

Stainless-steel connectors are also available for high and severe exposure environments or applications using certain preservative-treated woods. See pp. 49–50 for more detail.

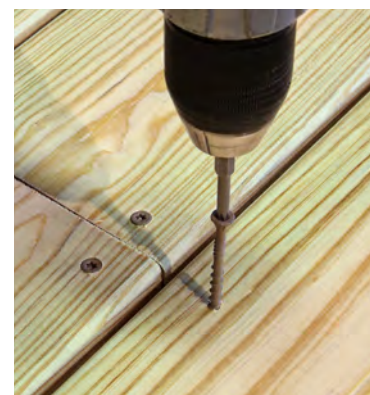

For more information on fasteners, please see our *Fastening Systems catalog* at [strongtie.com](http://strongtie.com).

# Color-Match Fasteners for Composite and PVC Decking

## Decking Meets Its Match

Simpson Strong-Tie® color-matched hand-drive and collated fasteners are available in a color palette specifically formulated to match a wide range of the most popular decking systems and are designed to blend into the decking material.

**Trim-Head PVC Decking:** Azek, TimberTech, Trex, Veka Deck

**Composite or Encapsulated Decking:** ChoiceDek, Evergrain, Fiberon, MoistureShield, TimberTech, Trex

For more information on Simpson Strong-Tie color-match fasteners, please refer to [strongtie.com/colormatchingguide](http://strongtie.com/colormatchingguide).

AZEK, ChoiceDek, Evergrain, Fiberon, MoistureShield, TimberTech and VekaDeck are trademarks or registered trademarks of their respective holders. Trex and Trex Escapes are registered trademarks of Trex Company, Inc.

## Composite or Encapsulated Composite Decking

### Deck-Drive™ DCU COMPOSITE Screw

- Cap head to reduce mushrooming and conceal installation
- Available in colors to match popular composite deck boards
- Available with Quik Guard® coating and stainless steel
- For more information, see our *Fastening Systems* catalog at [strongtie.com](http://strongtie.com)



### Deck-Drive DCU Screw Plugs

Deck-Drive DCU screw plugs provide a means of concealing the Deck-Drive DCU Composite screw heads used to fasten PVC and composite deck boards. The DCU screw plug solution can be ordered to color-match the deck boards, and comes with countersinking driver bits for hand drive, as well as for Quik Drive® auto-feed screw driving systems.

- For PVC and composite decks and trim boards
- Made from major manufacturer deck and trim boards



## PVC Decking Fasteners

### Trim-Head Screw, Stainless Steel, 6-Lobe Drive

- Trim-style head reduces appearance of installed fasteners on deck surface
- Available in colors formulated to match popular PVC deck systems



## PVC and Composite Fascia Fastening

### Fascia-Fastening Solution™

To properly install color-matched fasteners into a composite or PVC fascia board, proper fastener spacing and counter-boring is necessary. The Fascia-Fastening Solution provides the means to accomplish this for a professional finish.

- Type 316 stainless steel, color-matching fasteners for 1/2"-3/4" thick fascia boards
- Installs easily with the fascia counterbore bit and T20 6-lobe bit

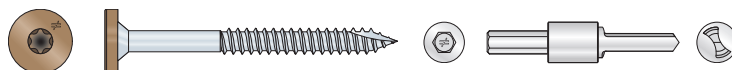

**Trex®** Deck-Drive DCU Composite screws are approved by Trex for Trex 1" x 6" and 2" x 6" composite decking.

# Hidden Deck Fastening

## EB-TY® Premium Hidden Deck-Fastening System™

**For wood decks including exotic hardwoods, redwood and cedar**

The EB-TY Premium Hidden Deck-Fastening System is the ideal solution that blends strength with ease of installation in a fastener that won't detract from the deck's finished appearance. EB-TY Premium integrates a Type 300 series stainless-steel reinforcing plate into its connection biscuit. The plate adds stiffness to hold boards in place securely, yet maintains flexibility when seasonal contraction and expansion occur. The EB-GUIDE predrilling tool helps install EB-TY Premium with precision and ease. Ipê wood plugs included.

### Features:

- Provides greater holding power and increased pullover resistance
- Type 300 series stainless-steel plate ensures lasting durability in demanding environments
- Prevents over-driving of the screw, helping to ensure consistent, quality installations
- Angled screw attachment ensures direct attachment of the board to the joist and prevents board movement
- EB-TY Premium covers the joist to protect it from exposure to sun and rain
- Chamfered edges for easier board alignment and installation of successive boards
- 3/16" and 1/4" spacings offer expansion compensation
- Additional Ipê wood plugs can be purchased separately

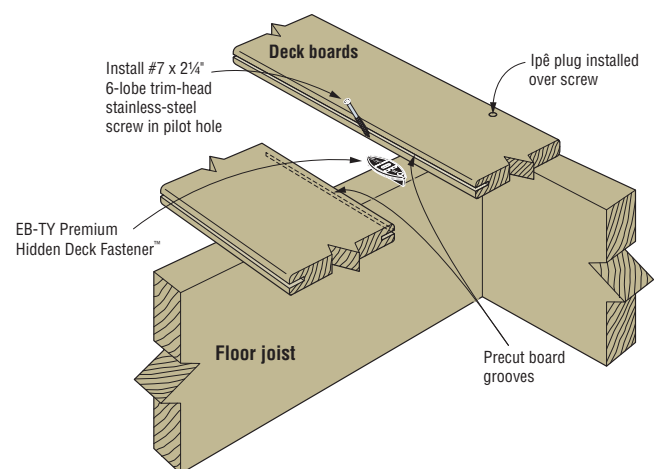
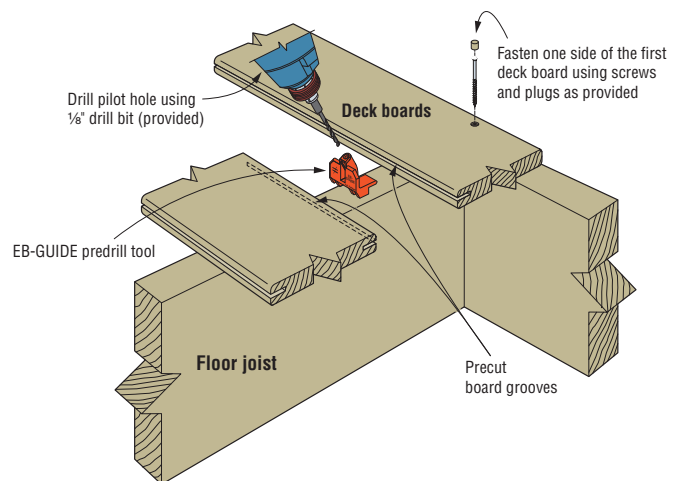

EB332W Series



EB316W Series



EB14W Series

**Note: For composite decking, use 175-EBTY and 175-EBTT and color-matched DCU Screw Plugs to fasten the end boards.**





# Nails for Decking

## Building Code Requirements

- Wood decking shall be attached to each supporting member with not less than (2) 8d threaded nails or (2) No. 8 wood screws.

*IRC 2018/2021 Section R507.7*



Stainless-steel connectors are also available for high and severe exposure environments or applications using certain preservative-treated woods. See pp. 49–50 for more detail.



## Stainless-Steel Nails

### Hand-Drive Decking and Trim Nails



### 15° Wire Coil, Full Round Checkered Head, Ring Shank

Types 304 and 316 Stainless Steel



### 20°–22° Plastic Strip, Full Round Checkered Head, Ring Shank

Types 304 and 316 Stainless Steel

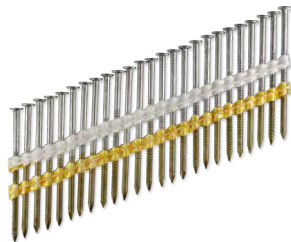

### 20°–22° Plastic Strip, Full Round Smooth Head, Screw Shank

Types 304 and 316 Stainless Steel

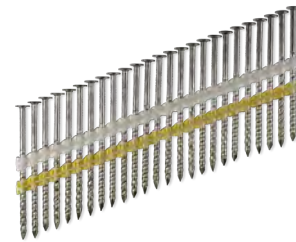

### 20°–22° Plastic Strip, Checkered, Casing Head, Ring Shank

Type 304 Stainless Steel

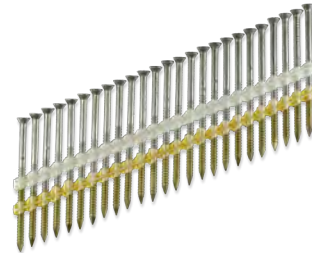

### 28° Wire Weld, Clipped Smooth Head, Ring Shank

Type 304 Stainless Steel

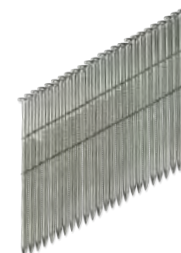

### 31°–34° Plastic Strip, Full Round Checkered Head, Ring Shank

Types 304 and 316 Stainless Steel

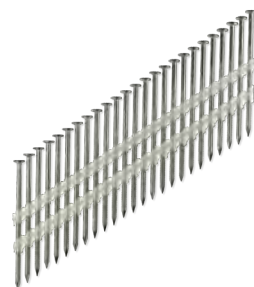

### 31°–34° Paper Tape, Clipped Smooth Head, Ring Shank

Types 304 and 316 Stainless Steel

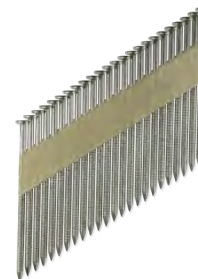

For more information on fasteners, please see our *Fastening Systems* catalog at [strongtie.com](http://strongtie.com).



# Quik Drive® Auto-Feed Screw Driving Systems for Decking

Quik Drive auto-feed screw driving systems are ideal for fastening decking because they combine the efficiency of stand-up driving with the holding power of screws, providing the best long-term results.

## Deck-Drive™ DSV WOOD Screw

Rimmed flat head with nibs,  
Quik Guard® coating in red, tan and gray.  
US Patent 9,482,258



## Deck-Drive DHPD HARDWOOD Screw

Paddle-style drill point, Type 305 stainless steel

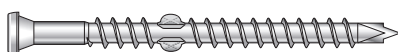

## Deck-Drive DWP WOOD SS Screw

Flat head with nibs, available in Types 305  
and 316 stainless steel

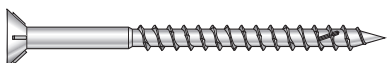

## Trim-Head Screw

#7 trim head, Type 305 stainless steel



## Deck-Drive DCU COMPOSITE Screw

Available with Quik Guard coating in 11 colors  
or in Types 305 and 316 stainless steel.  
DCU Composite screws are load rated for uplift  
resistance. See L-F-DCUPLIFT18.

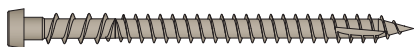

## Bugle-Head Wood Screw

#10 bugle head, available in Types 305  
and 316 stainless steel



## Building Code Requirements

- Wood decking shall be attached to each supporting member with not less than (2) 8d threaded nails or (2) No. 8 wood screws.

IRC 2018/2021 Section R507.7

Experience has shown that #7 stainless steel screws are acceptable for face screw fastening of hardwood and composite deck boards.

## Fastening for composite decking or using concealed fasteners:

IRC 2018/2021 Section R507.2.2.5  
IBC 2018/2021 Section 2612.6

Wood Plastic Composite deck boards shall be installed in accordance with the manufacturer's instructions and shall comply with the requirements of ASTM D7032 Section 5.6 Mechanical Fastener Holding Tests for the use of concealed clips. Simpson Strong-Tie recommends consulting with the decking manufacturer for their recommendations.

## PROSDD/CCS+ Combo System

**Applications:** Decks/docks, subfloor, sheathing, wall plates, stair treads, fiber-cement siding, drywall

- Expanded depth settings for high-density materials
- Reversible and replaceable non-skid teeth
- Uniform toenailing and countersink on slick surfaces
- Two screw driving attachments for added versatility



Stainless-steel connectors are also available for high and severe exposure environments or applications using certain preservative-treated woods. See pp. 49-50 for more detail.

## PRO300S System

**Applications:** Decks/docks, subfloor, wall plates, stair treads

- Expanded depth settings for high-density materials
- Reversible and replaceable non-skid teeth
- Includes a decking nose clip to position decking screws quickly and precisely every time
- Uniform toenailing and countersink on slick surfaces
- Sure-grip guide tube increases stability for a broad range of screws
- Available with corded or cordless driver motors

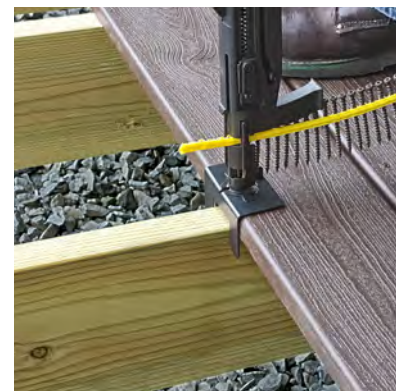

Shown with Deck Clip QDECKCLIP-RC

# Fastener Selection Guidance

# Connector Fastener Types

Many Simpson Strong-Tie connectors have been designed and tested for use with specific types and sizes of fasteners. The specified quantity, type and size of fastener must be installed in the correct holes on the connector to achieve published loads. Other factors, such as fastener material and finish, are also important. Incorrect fastener selection or installation can compromise connector performance and could lead to failure. For more information about fasteners, see our *Fastening Systems* catalog at [strongtie.com](http://strongtie.com) or access our Fastener Finder software at [strongtie.com/software](http://strongtie.com/software).



The Simpson Strong-Tie® Strong-Drive® SD Connector screw is the only screw approved for use with our connectors. Consult the current Simpson Strong-Tie *Wood Construction Connectors* catalog for complete fastener and fastening requirements.

The allowable loads of stainless-steel connectors match those of carbon-steel connectors when installed with Simpson Strong-Tie stainless-steel, SCNR ring-shank nails. For more information, refer to the *Fastening Systems Technical Guide*.

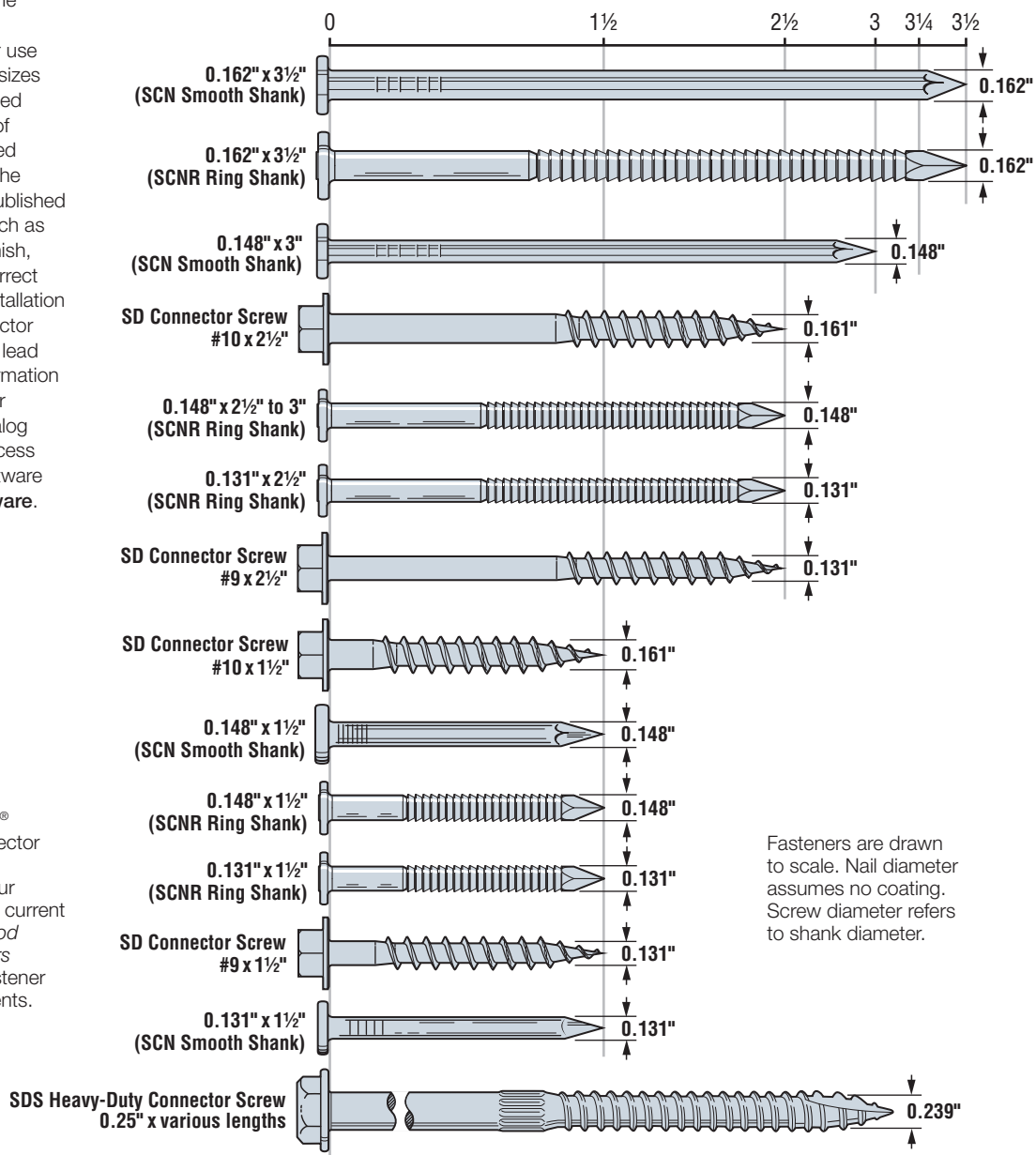

Fasteners are drawn to scale. Nail diameter assumes no coating. Screw diameter refers to shank diameter.

# Fastener Information

## Fastening Identification

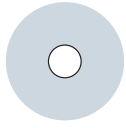

**Round Holes**  
**Purpose:** To fasten a connector.  
**Fill Requirements:** Always fill, unless noted otherwise.

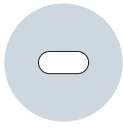

**Obround Holes**  
**Purpose:** To make fastening a connector in a tight location easier.  
**Fill Requirements:** Always fill, unless noted otherwise.

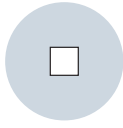

**Square Holes**  
**Purpose:** To fasten a connector.  
**Fill Requirements:** Always fill, unless noted otherwise.

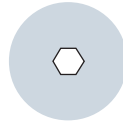

**Hexagonal Holes**  
**Purpose:** To fasten a connector to concrete or masonry.  
**Fill Requirements:** Always fill when fastening a connector to concrete or masonry.

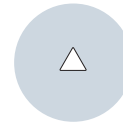

**Triangular Holes**  
**Purpose:** To increase a connector's strength or to achieve max. strength.  
**Fill Requirements:** When the designer specifies max. nailing.

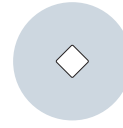

**Diamond Holes**  
**Purpose:** To temporarily fasten a connector to make installing it easier.  
**Fill Requirements:** None.

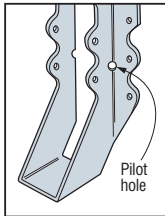

**Pilot Holes**  
Tooling holes for manufacturing purposes. No fasteners required.

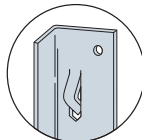

**Speed Prongs**  
Used to temporarily position and secure the connector for easier and faster installation.

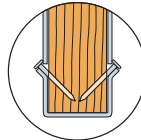

**Positive Angle Nailing (PAN)**  
Provided when wood splitting may occur, and to speed installation.

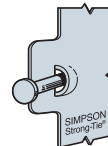

**Dome Nailing**  
This feature guides the nail into the joist and header at a 45° angle.

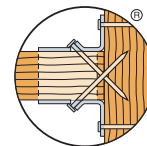

**Double-Shear Nailing**  
The nail is installed into the joist and header, distributing the load through two points on each joist nail for greater strength. Double-shear nailing must be full-length catalog nail.

## Incorrect Applications

### Short Nails

Do not use short (1 1/2") nails for double-shear nailing.

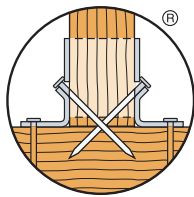

**Double-shear nailing shall use minimum 2 1/2" long nail or SD Connector screws.**

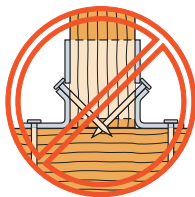

**Shorter nails shall not be used as double-shear nails.**

### Power Nailing

Collated framing-nailer fasteners can only be used if:

1. Correct diameter and length are installed
2. Correct material or finish is installed
3. Correct quantity is installed
4. Nails are driven with a hole-locating tool (finds the hole) or by hand
5. A full, round concentric head is required

### NOTE:

- Nails with 0.131" diameter may not be used to replace 10d common or 16d sinker nails
- Do not overdrive
- Drive only through punched holes

Power-driven nails must meet ASTM A153 Class D or equivalent specification for ZMAX® or hot-dip galvanized applications. As most framing nails are only zinc-plated, please ensure that the nails used with ZMAX connectors are hot-dip galvanized to meet ASTM A153.

Consult the current Simpson Strong-Tie *Wood Construction Connectors* catalog for complete fastener and fastening requirements.

# Mitigating Corrosion Risk



# Selecting Connector and Fastener Coatings

## Corrosion Issues

When selecting hardware or fasteners for deck construction, it is important to use connectors and fasteners with a level of corrosion resistance appropriate to the application.

Connectors and fasteners are exposed to the weather and often treatment chemicals in outdoor environments leading to an increased corrosion hazard. If building a deck in an area especially prone to moisture, such as along the coast or near bodies of water, the risk of corrosion is much higher. In addition, the chemicals used in some preservative-treated woods have been found to increase the corrosion of connectors and fasteners. Other corrosion risk factors include exposure to fire retardants, fumes, fertilizers, soil, industrial zones, acid rain and other corrosive elements.

Depending on the deck materials and environmental conditions, Simpson Strong-Tie® ZMAX® coated (G185) and hot-dip galvanized (HDG) connectors and fasteners may provide adequate corrosion resistance. If you choose to use ZMAX or HDG on your deck project, you should periodically inspect your connectors and fasteners or have a professional inspection performed. When using ZMAX/HDG connectors, you must use fasteners galvanized per ASTM A153, SDS screws with a double-barrier coating, or SD screws with a mechanically galvanized coating.

For high and severe corrosion applications, stainless-steel connectors and fasteners offer the best defense against corrosion. Simpson Strong-Tie offers a variety of connectors and fasteners in stainless steel for deck construction.

For more information on corrosion and selecting the appropriate finish for your application, visit [strongtie.com/info](http://strongtie.com/info).

## The Science Behind Stainless Steel

Simpson Strong-Tie connectors are available in Type 316 stainless steel, and Simpson Strong-Tie fasteners are available in either Type 316 or Type 304/305 stainless steel. Type 300 Series stainless steels contain chromium that is activated on the surface as chromium oxide and protects the base metal from corrosive attack. Type 316 stainless steel contains molybdenum, which increases corrosion resistance in chloride-containing exposures, such as saltwater environments.

### Common Conditions That Can Affect Corrosion Resistance of Metal Connectors and Fasteners

- Ocean salt air
- Water
- Preservative-treated wood
- Fire retardant-treated wood
- Salt used to de-ice or melt snow
- Pool or hot tub chemicals
- Fertilizers
- Soil
- Industrial zones
- Concrete
- Weather exposure

*Always Use Stainless-Steel Fasteners with Stainless-Steel Connectors*

The allowable loads of stainless-steel connectors match those of carbon-steel connectors when installed with Simpson Strong-Tie® stainless-steel, SCNR ring-shank nails. For more information, refer to the *Fastening Systems Technical Guide*.

Go to [strongtie.com/stainlesssteel](http://strongtie.com/stainlesssteel) for more information regarding stainless-steel fasteners and connectors.



**Dry Service**

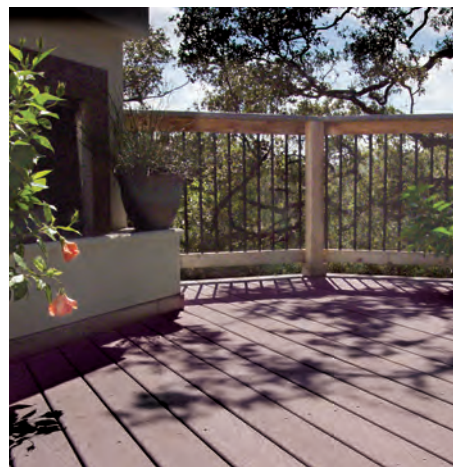

**Wet Service**



**High/Severe**



# Corrosion Information

## Corrosion Resistance Classifications

Environment	Material to Be Fastened						
	Untreated Wood or Other Material	Preservative-Treated Wood					FRT Wood
		SBX-DOT Zinc Borate	Chemical Retention ≤ AWPA, UC4A	Chemical Retention > AWPA, UC4A	ACZA	Other or Uncertain	
Dry Service	Low	Low	Low	High	Medium	High	Medium
Wet Service	Medium	N/A	Medium	High	High	High	High
Elevated Service	High	N/A	Severe	Severe	High	Severe	N/A
Uncertain	High	High	High	Severe	High	Severe	Severe
Ocean/Water Front	Severe	N/A	Severe	Severe	Severe	Severe	N/A



- Always consider the importance of the connection as well as the cost of maintenance and replacement.
- If the information about treatment chemicals in an application is incomplete, or if there is any uncertainty as to the service environment of any application, Simpson Strong-Tie recommends the use of a Type 300 Series stainless steel. Simpson Strong-Tie has evaluated the corrosion effects of various formulations of wood treatment chemicals ACZA, ACQ, CCA, MCA, CA, and salt as corrosion accelerators. Simpson Strong-Tie has not evaluated all formulations and retentions of the named wood treatment chemicals other than to use coatings and materials in the severe category. Manufacturers may independently provide test results or other product information. Simpson Strong-Tie expresses no opinion regarding such information.
- Type 316/305/304 stainless-steel products are recommended where preservative-treated wood used in ground contact has a chemical retention level greater than those for AWPA UC4A; CA-C, 0.15 pcf; CA-B, 0.21 pcf; micronized CA-C, 0.14 pcf; micronized CA-B, 0.15 pcf; ACQ-Type D (or C), 0.40 pcf. When wood treated with micronized CA-C and micronized CA-B with treatment retentions up to UC4B is in dry service, hot-dip galvanized fasteners and connectors may be suitable.
- Mechanical galvanizations C3 and N2000 should not be used in conditions that would be more corrosive than AWPA UC3A (exterior, above ground, rapid water run off).
- Some chemically-treated wood may have chemical retentions greater than specification, particularly near the surface, making it potentially more corrosive than chemically-treated wood with lower retentions. If this condition is suspected, use Type 316/305/304 stainless-steel, silicon bronze, or copper fasteners.
- Some woods, such as cedars, redwood, and oak, contain water-soluble tannins and are susceptible to staining when in contact with metal connectors and fasteners. According to the California Redwood Association ([calredwood.org](http://calredwood.org)), applying a quality finish to all surfaces of the wood prior to installation can help reduce staining.
- Anchors, fasteners and connectors in contact with FRT (fire retardant treated) lumber shall be hot-dip galvanized or stainless steel, unless recommended otherwise by the FRT manufacturer. Many FRT manufacturers permit low-corrosion-resistant connector and fastener coatings for dry-service conditions.
- Simpson Strong-Tie does not recommend painting stainless-steel anchors, fasteners or connectors. Imperfections or damage to the paint can facilitate collection of dirt and water that can degrade or block the passive formation of the protective chromium oxide film. When this happens, crevice corrosion can initiate and eventually become visible as a brown stain or red rust. Painting usually does not improve the corrosion resistance of stainless steel.

## Coatings and Materials Available for Connectors

Level of Corrosion Resistance	Coating or Material	Description	Fastener Material or Finish
<b>Connectors</b>			
Low	<b>Gray Paint</b>	Organic paint intended to protect the product while it is warehoused and in transit to the jobsite.	Bright, Hot-Dip Galvanized, Mechanically Galvanized, or Double-Barrier Coating
	<b>Powder Coating</b>	Baked-on paint finish that is more durable than standard paint.	
	<b>Galvanized</b>	Standard (G90) zinc-galvanized coating containing 0.90 oz. of zinc per square foot of surface area (total both sides).	
Medium		Galvanized (G185) 1.85 oz. of zinc per square foot of surface area (hot-dip galvanized per ASTM A653) total for both sides. Products with a powder-coat finish over a ZMAX® base have the same level of corrosion resistance.	Hot-Dip Galvanized, Mechanically Galvanized, or Double-Barrier Coating <i>* Bright fasteners may be used with ZMAX or HDG connectors where low corrosion resistance is allowed.</i>
		Products are hot-dip galvanized after fabrication (14 ga. and thicker). The coating weight increases with material thickness. The minimum average coating weight is 2.0 oz./ft. <sup>2</sup> (per ASTM A123) total for both sides. Anchor bolts are hot-dip galvanized per ASTM F2329.	
High/Severe	 <b>Type 316 Stainless Steel</b>	Type 316 stainless steel is a nickel-chromium austenitic grade of stainless steel with 2-3% molybdenum. Type 316 stainless steel is not hardened by heat treatment and is inherently nonmagnetic. It provides a level of corrosion protection suitable for severe environments, especially environments with chlorides.	Type 316 Stainless Steel

# Corrosion Information

## Coatings and Materials for Fasteners and Anchors

Level of Corrosion Resistance	Coating or Material	Description
<b>Fasteners and Anchors</b>		
Low	Bright	No surface coating.
	Electrocoating (E-Coat™)	Electrocoating utilizes electrical current to deposit the coating material on the fastener. After application, the coating is cured in an oven. Electrocoating provides a minimum amount of corrosion protection and is recommended for dry, low-corrosive applications.
	Clear, Yellow, and Bright Zinc, ASTM F1941	Zinc coatings applied by electrogalvanizing processes to fasteners that are used in dry service and with no environmental or material corrosion hazard.
	Phosphate (gray/black)	Gray phosphate provides a minimum level of corrosion resistance and is intended for dry, low-corrosive applications. Black phosphate provides a minimum level of corrosion resistance and is intended for dry, low-corrosive applications.
	Type 410 Stainless Steel	Type 410 stainless steel is a low-carbon martensitic grade of stainless steel that can be hardened and is inherently magnetic. This material provides corrosion resistance in mild atmospheres and many mild chemical environments.
	Heavy Electro-Galvanized (ASTM A641 – Class 1)	Electroplated zinc applied in accordance with ASTM A641, Class 1. This is an electroplated zinc coating that provides a low level of corrosion resistance. The Class 1 coating has no specified red rust performance criteria in the B117 salt spray test.
Medium	 ASTM A153, Class D	Hot-dip galvanized fasteners 5/8" and smaller in diameter in accordance with ASTM A153, Class D. Hot-dip galvanized fasteners are compliant with the 2018 and 2021 IRC and IBC.
	Type 410 Stainless Steel with Protective Top Coat	Carbon martensitic grade of stainless steel that is inherently magnetic, with an added protective top coat. This material can be used in mild atmospheres and many mild chemical environments.
	Mechanically Galvanized Coating, ASTM B695, Class 55	Simpson Strong-Tie® Strong-Drive SD Connector screws are manufactured with a mechanically applied zinc coating in accordance with ASTM B695, Class 55, with a supplemental overcoat. These fasteners are compatible with painted and zinc-coated (G90 and ZMAX®) connectors and are recognized in evaluation reports that can be found on <a href="http://strongtie.com">strongtie.com</a> .
	Quik Guard® Coating	Quik Guard is a proprietary coating that consists of an electroplated zinc base layer and a system of organic top coats.
	Double-Barrier Coating	Simpson Strong-Tie Strong-Drive SDS Heavy-Duty Connector screws and Outdoor Accents® structural wood screws are manufactured with a double-barrier coating that provides a level of corrosion protection equaling that provided by HDG coating and are recognized in evaluation reports that can be found on <a href="http://strongtie.com">strongtie.com</a> .
High	Type 304 Stainless, Type 305 Stainless	Types 304 and 305 stainless steels are nickel-chromium austenitic grades of stainless steel. Types 304 and 305 stainless steels are not hardened by heat treatment and are inherently nonmagnetic.
Severe	 ASTM A153, Class C	Simpson Strong-Tie Strong-Drive Timber-Hex screws are hot-dip galvanized in accordance with ASTM A153, Class C. These hot-dip galvanized fasteners have a minimum average of 1.25 oz./ft. <sup>2</sup> of zinc coating and are compliant with the 2018 and 2021 IRC and IBC.
	 Type 316 Stainless Steel	Type 316 stainless steel is a nickel-chromium austenitic grade of stainless steel with 2–3% molybdenum. It provides a level of corrosion protection suitable for severe environments, especially environments with chlorides. Type 316 stainless-steel fasteners are compliant with the 2018 and 2021 IRC and IBC.



# Build your customer's ultimate backyard dream.



Deck Planner Software™



Pergola Planner Software™



Fence Planner Software™

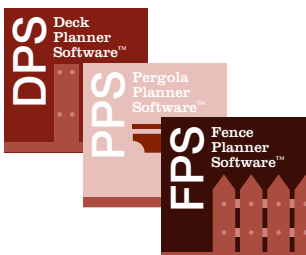

**Plan, quote and build outdoor structures faster and easier.** Grow your construction business with free Outdoor Living software from Simpson Strong-Tie. Our design apps include Deck Planner Software™, Pergola Planner Software™ and Fence Planner Software™. The in-app tutorials make it easy to select materials, dimensions, colors and hardware. Add patios, sheds, landscaping or other features, then show customers their entire yard in a realistic 2D or 3D view. Once your design is complete, you can print a full materials list, provide a quote, review permit submittal pages, and select a local dealer with available supplies in your area.

Download free design software at [go.strongtie.com/outdoorliving](https://go.strongtie.com/outdoorliving). Or call (800) 999-5099 to learn more.





*Outdoor Accents®*



**Easy to install.  
Built to last.**



Strength and selection go together with Outdoor Accents® decorative hardware from Simpson Strong-Tie. We're always expanding our Mission Collection® and Avant Collection™ lines with new products and accessories, making it easy to enhance outdoor structures and living spaces. Both lines feature an innovative hex-head washer and fastener combo for the look of a bolted connection that installs as easily as driving a screw. Plus, our code-listed connectors and fasteners are rigorously tested for performance. So whether you're building a planter box or a pavilion, it will be strong, safe and beautiful for years to come.

To see our complete lines of Outdoor Accents decorative hardware and download free project plans, visit [go.strongtie.com/outdooraccents](http://go.strongtie.com/outdooraccents) or call (800) 999-5099.



This flier is effective until December 31, 2024, and reflects information available as of March 1, 2022. This information is updated periodically and should not be relied upon after December 31, 2024. Contact Simpson Strong-Tie for current information and limited warranty or see [strongtie.com](http://strongtie.com).